

CNCelite

NEXT GENERATION CNC SOLUTIONS

FAGOR
AUTOMATION



Open
to your
world



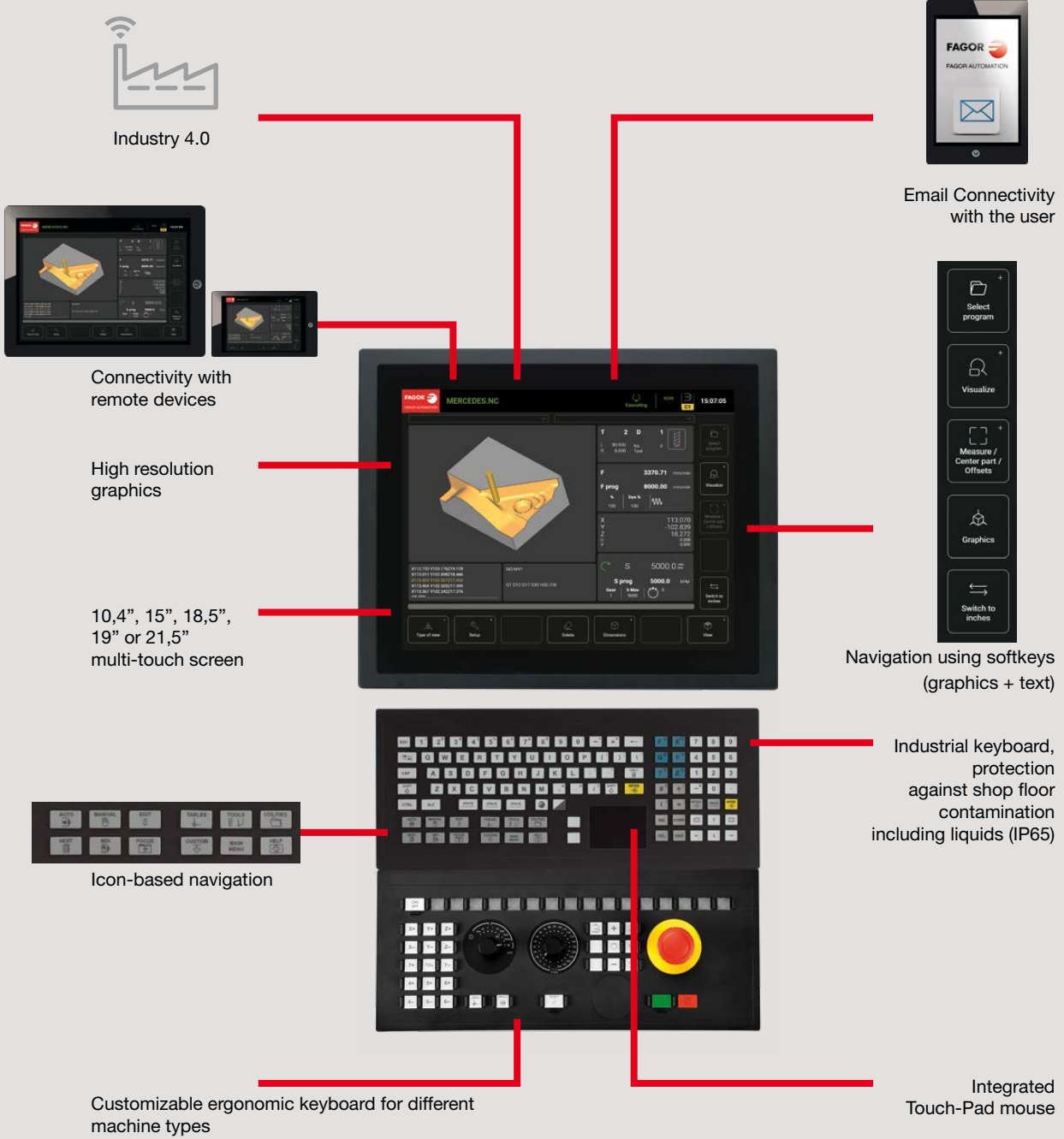

Leading technologies- Ready to Use

Powerful. Futuristic. Technologically advanced. All inclusive. The next generation transformational technology that leaves everything else behind. This new system comes stacked with host of outstanding new features.



Large memory for your ever increasing requirements

Depending on the model, Fagor CNC offers 3 or 8 Gb of free memory as standard. User can add/increase the memory by connecting a USB stick or installing a CFast memory, and run part programs from these devices.

Virtual workstation

You may download a CNC simulator from our corporate website to completely simulate the behavior of your machine considering actual feeds, speeds, etc.

Its most common use will be:

- Technical training for programmers and operators.
- Editing/Simulation in design departments.
- Machining time estimate.
- Preparing quotation for machining parts.
- Training centers and remote learning.

Network connectivity

All Fagor CNCs offer, as standard, connectivity via Ethernet to the company network or to the cloud for transferring files, sharing data, integration into intelligent environments or even access the hard disk of a remote PC to store your programs.

Integration of the customer's software & hardware

Fagor's systems have been created using an open concept. Using a design based on industrial PC technology, it allows you to integrate your management programs, programming tools, barcode readers, laser devices, cameras, sensors, etc., which can be synchronized with specific CNC functions.

TOOLS

FOR PRODUCTIVITY AND MAINTENANCE

By offering most advanced tools for production control and maintenance we can ensure your machine performance is always maximized.

Fagor and Industry 4.0

The emergence of new technology such as Artificial Intelligence and the Internet of Things has brought about a new wave of industrial development.

Fagor offers you the Connectivity Pack that enables easy integration of our CNCs into this type of Industry 4.0 environment. We provide you with international protocols for digital communication such as UMATI, MTConnect, OPC UA, MQTT, etc., which are the universal languages for communication with all the intelligent devices in your company.

Predictive maintenance

Using our free auto-tuning tool, FINETUNE you can evaluate and modify the current performance of your machine. This information can be easily compared to previously stored machine data and corrective measures can be performed, including detection of future mechanical failures.

Remote machining control

Certain operations do not require constant operator presence either because the process is highly automated or because the operation takes a long time.

During such processes Fagor's "Process Informer" feature can notify you via e-message if the process is interrupted or requires attention due to any possible errors allowing you to act immediately.

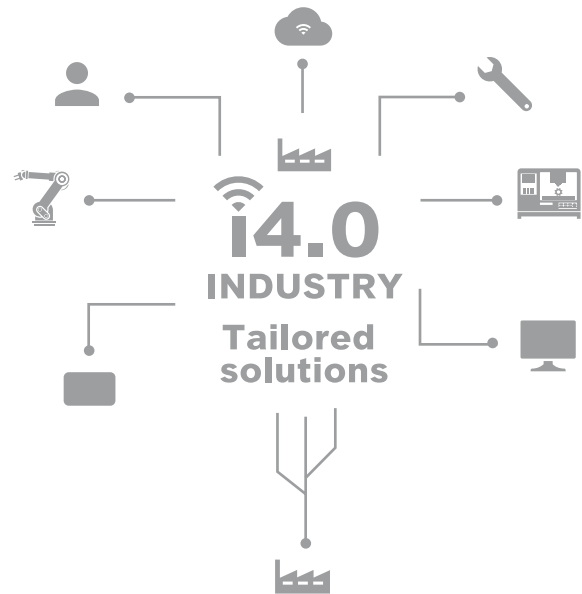

Additional Advanced Services

In addition to offering standard solutions for improving the machine shop productivity, Fagor also offers:

- Remote (On-line training).
- Machine customization services including:
 - Process adaptation at workplace.
 - Maintenance schedules
 - Productivity management and control.
- Connection of your machines to Industry 4.0 environments. Interconnection of your old and new machines.

Our commercial & service network consists of more than 30 branch offices and 40 official distributors worldwide, offering local and on-site service.



Telediagnosis (Remote Troubleshooting)

From a remote location a technician can securely connect to your CNC to diagnose and solve issues you may have with your machine.

This powerful tool not only allows the technician to optimize axis and spindle tuning but also modify PLC, parameters, programs etc.



Integrated manuals

Following on our commitment towards environment protection and sustainability Fagor has adopted digital documentation for all technical products.

Every CNC has a built in library of all doumentations, which is only a “HELP” key away.



Maintenance modes

The new *elite* series CNC also offers a maintenance mode for your CNC. Utilizing an interactive and powerful HMI you can monitor the machine status and the history of incidents.



Training:

- Standard or customized courses
- On-line or in-person courses
- + More info at www.fagorautomation.com

A CUTTING-EDGE NAVIGATION SYSTEM

More intuitive,
simple and interactive.

Highly interactive and agile navigation

Utilizing a host of modern tools along with association from various prominent designers, helped us to create our most user friendly, creative and responsive work interface to date.

The HTML5 platform used for the development allows the CNC's interface to be connected to all types of devices such as smartphones, tablets ...

Drop-down menus

We provide a pop-up menu system that allows for easier navigation and it eliminates cumbersome sub-levels that can be confusing.

Ergonomic keyboard

With new line of Fagor keyboards, data entry and navigation has been made a lot easier for the users. Additional improvements relating to axis input and technical functions have been added.

Working with a mouse

In addition to high quality touch screen (similar to one used in superior mobile devices) the new alphanumeric keyboard also provides a built-in Touch-pad mouse. You can also choose to connect a conventional mouse to a USB port.

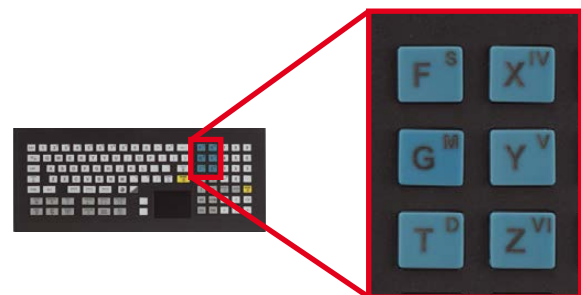
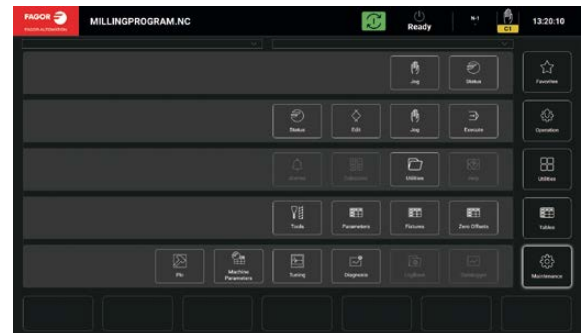

Visual and modern
navigation



Drop-down
menus



Ergonomic
keyboard



Working with
a mouse



User customizable HMI

The OEM manufacturer can easily adapt the machine to specific application and the working environment.

The new standard interface allows you to adapt specific work modes and cycles etc. to suit your needs. You can also add or remove specific functions making the navigation seamless.



Built-in calculator

In production areas, it is very common to use digital calculators to enter data, calculate new offsets, etc. Fagor CNCs provide you with a built-in calculator as standard so that you can make these calculations directly, avoiding any possible errors. The calculations can be directly inserted into desired location.



FMC (Fagor Machining Calculator)

Also available at your fingertips is an advanced machining conditions' calculator where all you have to do is enter information related to the materials, tools and operations you plan to use.

With this information the CNC will provide the optimum machining conditions which will be written directly into the program.

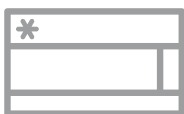

Customization



Built-in calculator

NUMEROUS POSSIBILITIES

FOR RUNNING YOUR PROGRAMS IN AN EFFICIENT AND PRODUCTIVE WAY

Choose the programming format that suits you best.

Standard ISO language

In addition to offering complete ISO G code functionalities, Fagor also provides advance functions such as fixed (canned) cycles, scaling factors, coordinate rotations, etc.

During the programming of any function, by pressing the HELP key the CNC will show you information on how to use that function.

Parametric language programming

It allows more complex programming by performing mathematical calculations of tool paths, repetitions, etc.

For those repetitive tasks on the machines, the Fagor CNC allows you to create your sub-routines or cycles.

FGE (Fagor Geometry Editor)

This functionality inspired by CAD CAM software allows you to program complex shapes very intuitively at the machine, without the need for additional software.

It also includes a comprehensive DXF file import tool.

ProGTL3 language

When it is complicated to use parametric language to create complex shapes, Fagor offers you a high-level programming language called ProGTL3.

It allows you to program simple geometric elements as well as supporting figures that help you to create the desired shapes.

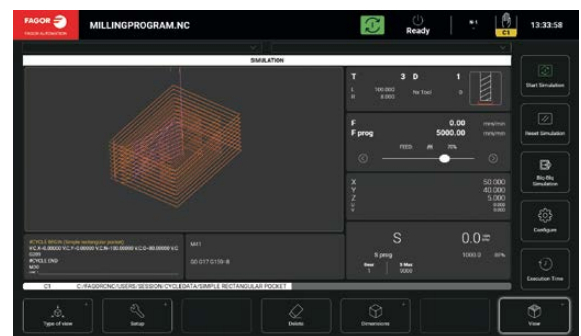

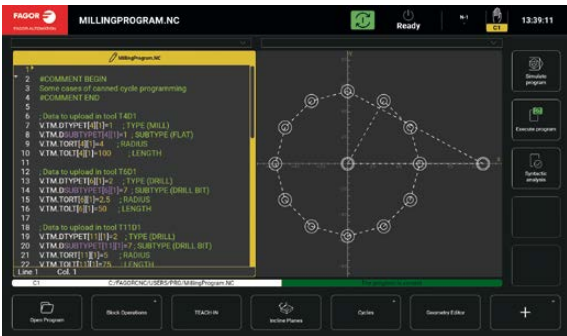

Graphic assistance for programming

This function allows you to simultaneously check, while editing the part, the result of its programming in graphic form.

Hence allowing you to optimize or fix programming errors even before the simulation.



IIP (Interactive Icon-based Pages) interactive language

Our programming language (IIP), based on one operation one screen concept, is the best conversational cycle-based programming in the CNC machining world today.

All you have to do is define the geometry of the part to be made, the tool and the machining conditions and the CNC will do the rest.

Complete flexibility

All the above-mentioned programming languages can be combined in a single program.

You can combine, if you wish, a CAD CAM generated program with conversational cycles.

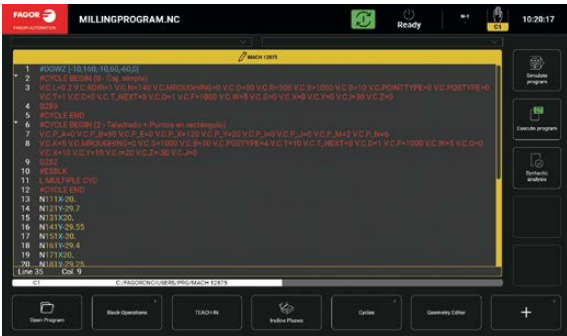

This can be useful if you need to prepare the part (surface milling, drilling, etc.) before machining the mould.

You can also transfer with ease programs created on older Fagor CNCs.

Semi-manual editing

Fagor CNC system also allows the user to operate the machine manually and he can save the physical positions of the tool in the program by means of the Teach-in function.

A part program can be created by following the steps and saved later for auto execution.



VERIFICATION AND PREPARATION OF TOOLS AND PARTS FOR MACHINING

Anticipate the end result.

HD graphics

The HD graphics are primarily useful in the following situations:

- Before machining: To check that the program is correct and prevent interference or collision with the finished part or the fixture.
- While machining: When the visibility is low (e.g. due to coolant or chips) and it is difficult to view the actual machining status at any time.



Measurements, pre-execution verification

While machining a part, the CNC offers you the possibility to prepare and simulate the next part.

- Zoom in/out, part rotation, etc.
- Select preset views of the part.
- Select the type of graphics to display.
- Define the part dimensions to be machined in the graphics.
- Display several views of the same part simultaneously.
- Take part measurements using graphics.

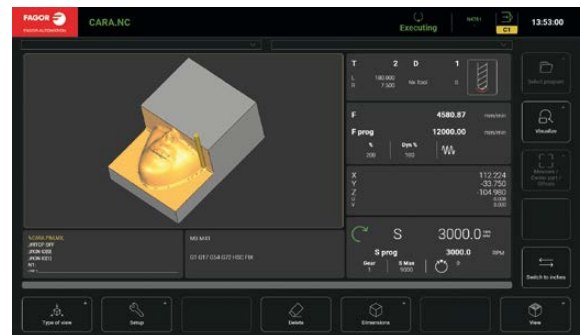

For complex parts you can slice the solid graphics in to one or more sections to view the part details closely.

Zero offsets

The CNC allows you, in a simple and intuitive way, to define a number of reference points on the machine and save them for later use. Each point has an absolute and an incremental part. The zero offset applied will be the sum of both.

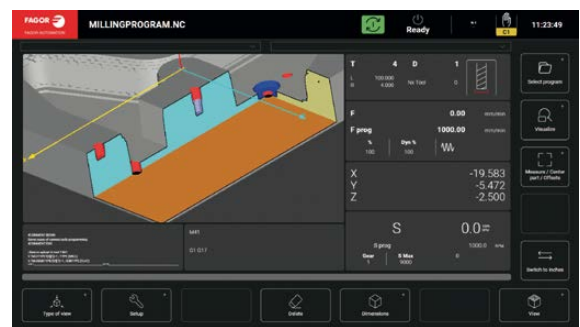

The incremental offset allows you to correct the position of the part without having to recalculate the zero for the part or re-edit the program.

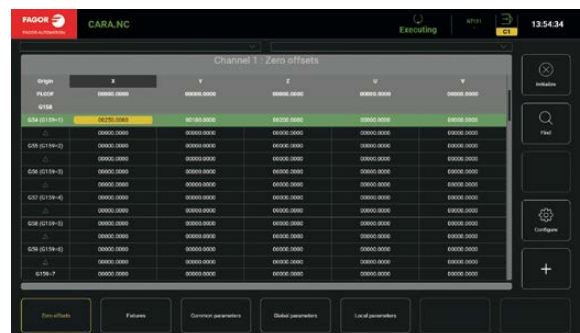

Management of all types of tools and magazines

Fagor CNCs are able to manage one or several tool magazines including tools that are currently not on the machine.

It allows you to define tools using graphic presentation:

- Tool number.
- Tool name.
- Tool geometry.
- Tool type.
- Spindle turning direction.
- Length, radius, wear, etc.

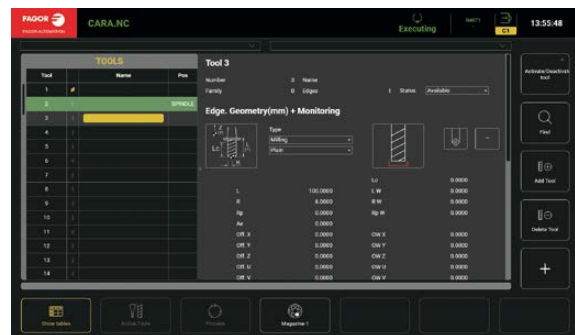

Tool calibration

Fagor gives you several options for calibrating your tools:

- Using a tool-presetter prior to machining.
- Using a master part of known dimensions.
- Automatically using probe probe cycles.
 - Using automatic probing cycles. This method makes it possible to achieve better accuracy and eliminates idle time.



Part centering

Fagor also features cycles to make it easier to define the exact position of the part in the machine:

- Manually guided by the CNC. By manually moving the tool close to the work-piece and validating the contact points.
- Automatically. Using a probe and the appropriate cycles.



Clamps

The clamps allow you to select the fastening system used when you have more than one clamping system.

Once you have selected the clamping system to be used, you can apply the rest of the zero points to it, which will be referred to as the active clamping system.



FEATURES FOR MILLING MACHINES*

At the forefront of high-speed, 5-axis machining Technology.

HSSA (High Speed Surface Accuracy)

The Fagor HSSA machining system offers the most advanced algorithms that seamlessly blend the tool path trajectories calculated to reduce vibrations and obtain high quality machining.

You can easily select the type of machining you want to obtain:

- As fast as possible (roughing)
- As accurate as possible
- The best surface quality

DMC (Dynamic Machining Control)

With this feature, the CNC automatically adapts the machining feed rate according to the tool force (load).

During machining when at critical moments, the spindle load is high or when the tool comes into contact with the material at the beginning of a cutting cycle, the feed rate is reduced to protect the tool and, when power consumption is low (spindle load), the machining feed rate increases to optimize the cutting.

All this happens automatically and with an auto self-learning process. User can define the active parameters during machining.

3+2 and 5-axis machining

Fagor offers you a complete solution for your machine with kinematics.

- Library of kinematics.
- Work in inclined planes, 3+2, 4+1, etc. and continuous 5-axis RTCP machining.

If, at anytime during the life of the machine tool it is necessary to readjust the kinematics, Fagor offers a conversational cycle that will carry out such corrections automatically.

FCAS (Fagor Collision Avoidance System)

The FCAS option (Fagor Collision Avoidance System) monitors tool movements in real time to avoid collisions with in the machine's working envelop.

When the FCAS option detects the possibility of a collision, it stops the movement, within the safety margin defined by the machine manufacturer, and will only allow away movement until it is in a safe area.

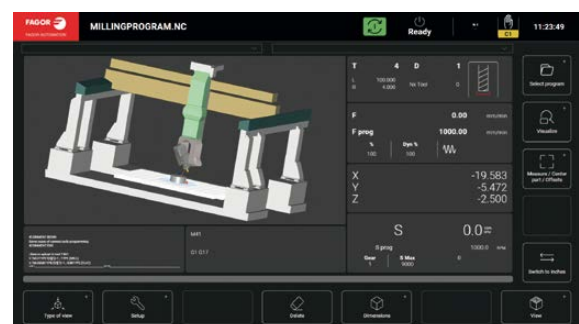
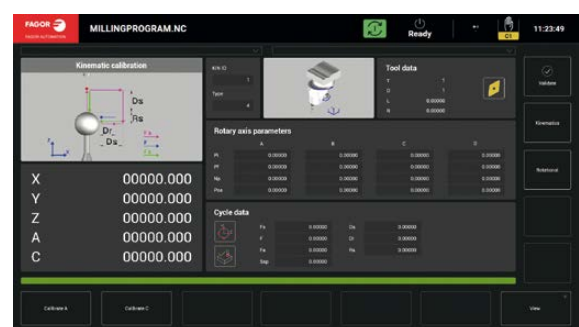
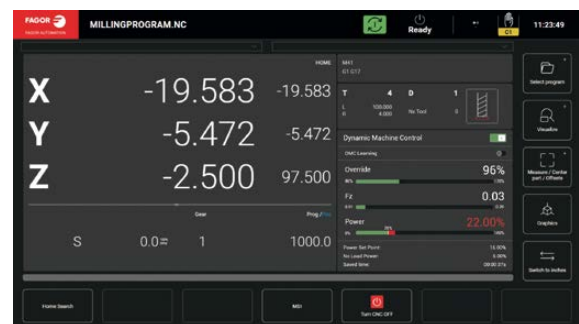
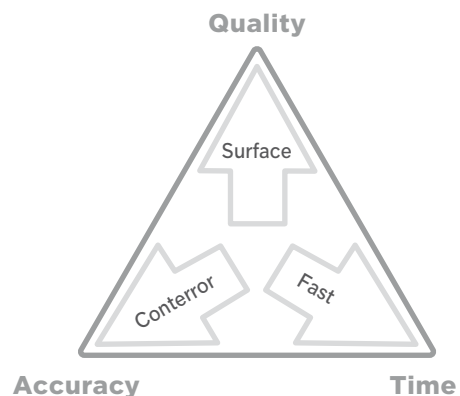



RTCP on a rotational plane

In addition to offering intuitive cycles to define the work planes, the inclination of the part, its position on the table, etc., the CNC can also perform simultaneous 5-axis machining on this defined surface.

This feature is very useful e.g. when we have to find the center of large work pieces- as now it can be done automatically.

* The functions on pages 12 and 13 are also available for Lathes.

FEATURES FOR LATHES

Multi-function, multi-turret lathes etc.
to increase the productivity of your workshop.

Lathe – Milling machine

To improve the productivity and accuracy of machining operations, it is becoming increasingly desirable for milling machines to perform some turning operations or vice-versa.

The Fagor CNC offers you the option of utilizing the full potential of the milling machine on a lathe and vice versa, providing a work environment and specific functions for such purposes.



Vertical and multi-channel lathes

Fagor CNCs have a specific operational (work) interface for vertical and multi-turret lathes.

Both the work interface and the fixed cycles or machine graphics are adapted to the specific configurations of such machine types.



DINDIST (Dynamic Distribution of machining operations)

We also offer specific features for the management and programming of multi-turret lathes.

DINDIST allows you to program on one of the CNC channels (as on a simple lathe) and the CNC will distribute the machining passes between the two turrets, saving considerable time in your machining operations.

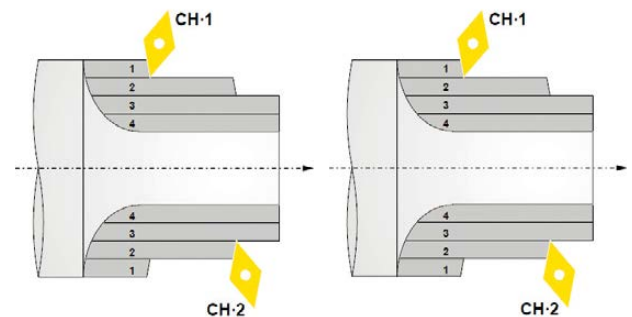

FFC (Fagor Feed Control)

When proving the part for the first time or during continuous machining if vibrations or chatter are observed (change of tool type etc.), it may be necessary to change the feed rate and spindle speed to obtain best results.

By utilizing FFC function a user can press a specific key so that the modified feeds and speeds are memorized by the program for the subsequent part cycles.

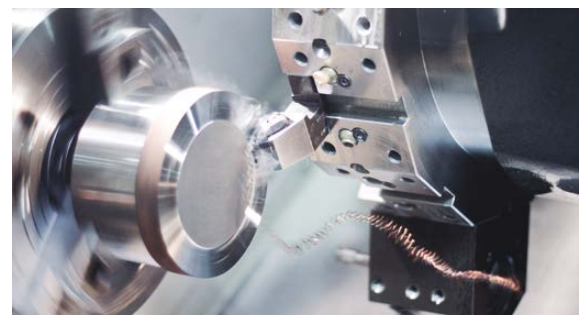

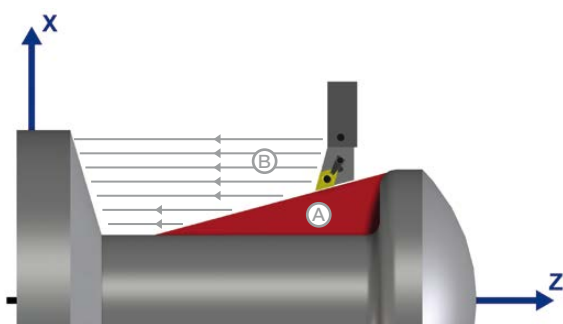

A. Machining error.
B. Machining direction.

Machining of excess material

Sometimes, because of the shape of the work-piece or the tool selected, it is not possible to remove all the material from the profile to be machined.

The Fagor CNC saves the information of the non-machined part and gives you the option to remove this material with the right tool and the machining conditions before finishing.

HELP FOR INCIDENTS

DURING MACHINING

| Solves unexpected situations.

Tool inspection

During machining you can check the status of the machining and take corrective actions such as:

- Change the machining conditions.
- Make a tool change if it is worn out or broken.
- Activate auxiliary devices like the coolant.

Tool life monitoring

Tool life monitoring is a very useful feature in long machining operations or in very repetitive productive processes.

The CNC automatically checks whether or not the tool has finished its useful life (set by the user) and replaces it with a similar one, continuing with the machining.

Recovery and continuation of machining

Occasionally, during the machining process, unexpected machine stops or shut-downs may occur.

The CNC allows you to automatically search for the point of interruption and restore the machining, from the same point or from a previous position (in case the user needs to repair the damage caused due to the incidence).

Wear control

Due to the prolonged use of the tools, they are subject to wear and tear, but are still useful for machining although their dimensions may have changed (length and diameter).

The CNC allows you to compensate for tool dimensions manually or automatically using specific cycles or tables.

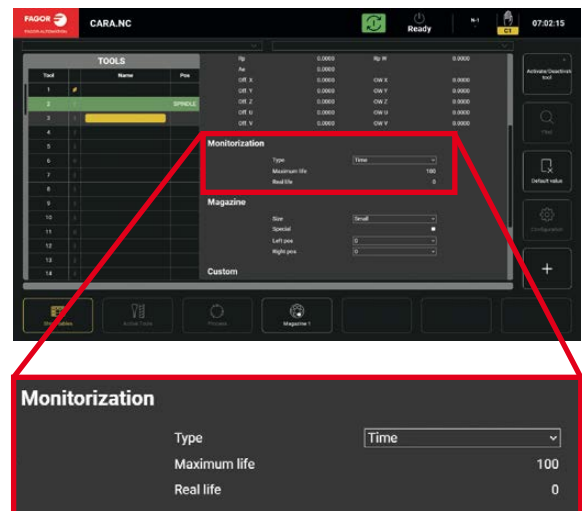

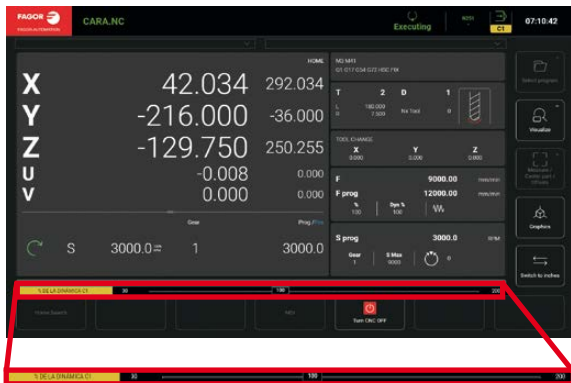

Dynamic override

Using the cursor on the screen you can quickly alter the machining behavior to suit your needs.

You can choose from various options depending on the prevailing conditions:

- If you observe vibrations or jerky movements they can be eliminated by adjusting the cursor (which in turn applies the algorithm to adjust feeds and speed) to obtain desired surface qualities.
- If the machine movement is very sluggish, it can be improved by adjusting the cursor to improve the machining time.



Cancel Continue

This option allows you to skip over certain segments of the part program during machining for reasons such as:

- Damaged tool.
- Irregular part shapes or damaged part.

Simply activate this function and select the block before or after it to restart the running of the program.

Control of the machining process

The Fagor CNC provides options to readily access the batch production data during manufacturing process.

The information provided includes number of parts completed and time remaining to complete the batch.

Virtual axis

On 5-axis machines it is possible to define an axis that moves in the direction of the tool.

If we activate it, the tool will move perpendicular to the surface of the work-piece when we use the handwheel or the JOG keys.

It can also be activated during the machining of parts.

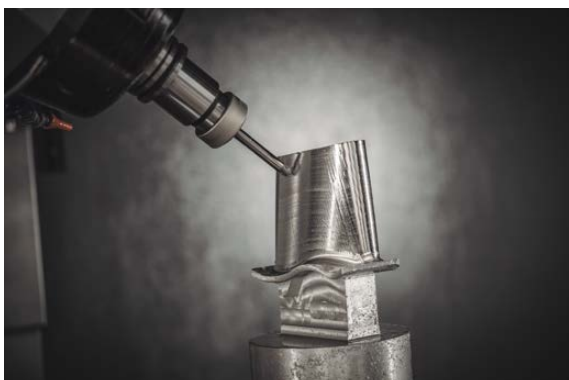

TECHNICAL CHARACTERISTICS

	CNC 8058elite	CNC 8060elite	CNC 8065elite
Main characteristics			
Monitor	10.4", 18.5" and 21.5"	10.4", 15", 18.5", 19" and 21.5"	10.4", 15", 18.5", 19" and 21.5"
Touch Screen	Δ (*)	Δ	Δ
Ethernet	•	•	•
USB connections (integrated /modular)	2/4	2/4	4/5
User memory (Available user memory may vary depending on the software installed)	Minimum 3 GB	Minimum 4.5 GB	Minimum 4.5 GB
Connector for CFast memory expansion	•	•	•
Maximum axis configuration	4	10	32
Maximum configuration of interpolated axes	4	4	32 (**) (***)
Maximum configuration of spindles	2	3	6 (**)
Maximum configuration of execution channels	1	2	4
Maximum configuration of nodes (axes + spindles)	5	10	32
Productivity and maintenance tools			
Finetune (Auto-adjustment & Predictive maintenance)	•	•	•
Process Informer (Incident messages)	•	•	•
Kinematics calibration	–	–	Δ
Maintenance mode	•	•	•
Tele-Diagnosis	•	•	•
Fagor I4.0 Connectivity Pack	Δ	Δ	Δ
Standard features			
Available languages	16 (****)	16 (****)	16 (****)
Integrated manuals	•	•	•
Pop-up navigation (drop-down menus)	•	•	•
Built-in calculator	•	•	•
FMC (Fagor Machining Calculator)	Δ	Δ	Δ
Machining time estimate	•	•	•
HD Graphic simulation	Δ	Δ	Δ
Zoom in simulation	•	•	•
Simultaneous execution and simulation	•	•	•
CNC language translator	Δ	Δ	Δ
Programming / Machining			
ISO and parametric language	•	•	•
IIP (Interactive Icon-based Pages) programming language	Δ	Δ	•
ProGTL3 language	–	Δ	•
Graphic assistance for programming	•	•	•
DXF converter	•	•	•
FGE (Fagor Geometry Editor)	•	•	•
Zero offsets	99x10 clamps	99x10 clamps	99x10 garras
Incremental zero offsets	99	99	99
Tool offset	100000	100000	100000
Tool geometry compensation	•	•	•
Tool measuring cycles	•	•	•
Tool and work-piece probe cycles	Δ	Δ	•
Block processing time	2 ms	1 ms	0.167 ms
Look-ahead blocks	150	300	2400

	CNC 8058elite	CNC 8060elite	CNC 8065elite
Programming / Machining			
Nanometric accuracy	●	●	●
Basic machining algorithms (HSSA I)	△	–	–
Advanced machining algorithms (HSSA II)	–	△	●
DMC (Dynamic Machining Control)	–	△	△
Dynamic Override	●	●	●
Dual-purpose (lathe & mill) machine	–	△	△
RTCP	–	△	△
FCAS (Fagor Collision Avoidance System)	–	–	△
Virtual axis	–	●	●
Additive & trajectory flywheel	●	●	●
Recovery & continuation of machining	●	●	●
Cancel Continue	●	●	●
Tool inspection	●	●	●
Tool life monitoring	●	●	●

Milling focused features

Tapping / rigid tapping	●	●	●
Helical interpolation	●	●	●
Drilling, tapping, boring and reaming cycles	●	●	●
Rectangular and circular pocket cycles	●	●	●
2D pockets for user-defined shapes	●	●	●
3D pockets with islands for user-defined shapes	●	●	●
Multiple pocket cycles	●	●	●
Bore milling cycle	●	●	●
Thread milling cycles	●	●	●
Milling cycles for 4th axis (C axis)	△	△	●
Kinematics calibration cycle	–	–	△
Inclined planes (3+2, 4+1, etc. work)	–	△	△
Machining 5 continuous axes	–	–	△

Turning focused features

Multiple cycles for turning	●	●	●
Multiple cycles for facing work	●	●	●
Wide selection of drilling and threading cycles	●	●	●
Constant-pitch and variable-pitch threading	●	●	●
Wide selection of threading cycles	●	●	●
Multiple grooving cycles	●	●	●
Profile cycle along the X & Z axes	●	●	●
Pocket cycles in the XC, ZC planes	●	●	●
Pocket cycles in the XY, YZ planes	–	●	●
Multiple pocket cycles	●	●	●
2D pockets for user-defined shapes	●	●	●
DINDIST (Dynamic Distribution of Machining operations)	–	●	●
FFC (Fagor Feed Control)	△	△	△

– Not available.

● Standard.

△ Optional.

(*) Not available on integrated models.

(**) Up to 10 interpolated axes, 32 interpolated axes under development.

(***) Products manufactured by Fagor Automation since April 1st 2014 will include “-MDU” in their identification if they are included on the list of dual use products according to regulation UE 428/2009 and require an export license depending on destination.

(****) English, Spanish, Italian, German, French, Basque, Portuguese, simplified Chinese, traditional Chinese, Russian, Czech, Korean, Turkish, Dutch, Polish and Swedish.

Other languages are available in the Downloads section from Fagor Automation's website.

Fagor Automation shall not be held responsible for any printing or transcribing errors in the catalog and reserves the right to make any changes to the characteristics of its products without prior notice.



Fagor Automation holds the ISO 9001 Quality System Certificate and the CE Certificate for all products manufactured.



Fagor Automation, S. Coop.
 B° San Andrés, 19
 E-20500 Arrasate - Mondragón
 SPAIN
 Tel.: +34 943 039 800
 Fax: +34 943 791 712
 E-mail: info@fagorautomation.es

www.fagorautomation.com



worldwide automation