

High reliability and high cost-performance Nano CNC

FANUC Series Oi-MODEL D

FANUC Series Oi Mate

-MODEL D

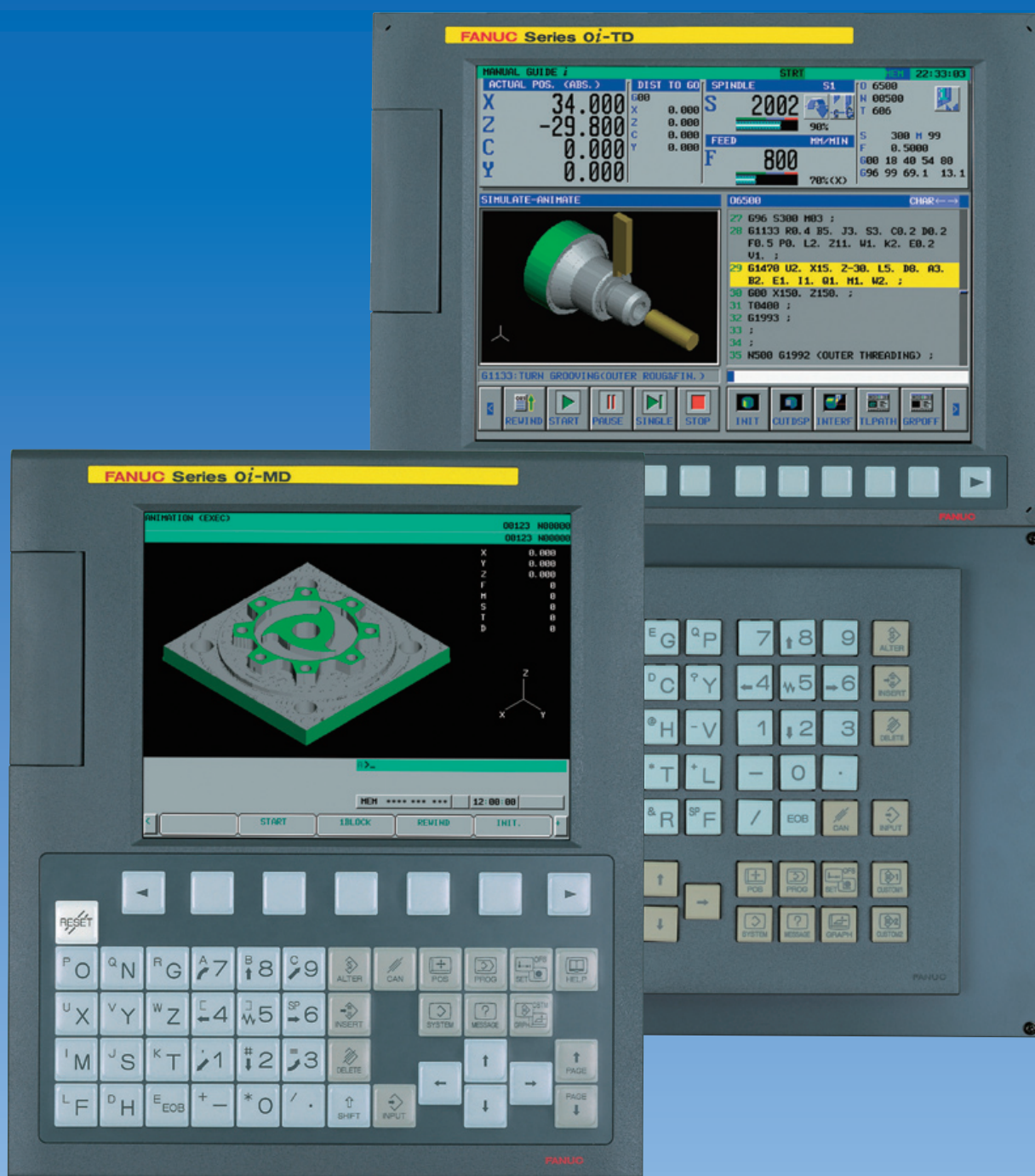

High reliability and high cost-performance Nano CNC

FANUC Series Oi-MODEL D

FANUC Series Oi Mate-MODEL D

FANUC Series Oi / FANUC Series Oi Mate are the high reliability and high cost-performance Nano CNCs.

FANUC Series Oi-MD

Suitable CNC for Machining center
Max. total number of control axes: 8 axes *1

FANUC Series Oi-TD

Suitable CNC for lathe
Max. total number of control axes in 1path system: 8 axes *1
Max. total number of control axes in 2path system: 11 axes *1

FANUC Series Oi Mate-MD

Suitable CNC for Machining center
Max. total number of control axes: 5 axes *1

FANUC Series Oi Mate-TD

Suitable CNC for lathe
Max. total number of control axes: 5 axes *1

(* 1 : Total number of control axes means the total of the numbers of feed axes and spindle axes. Refer to Specifications about the maximum feed axis number and the maximum spindle axis number of each CNC.)



Memory card

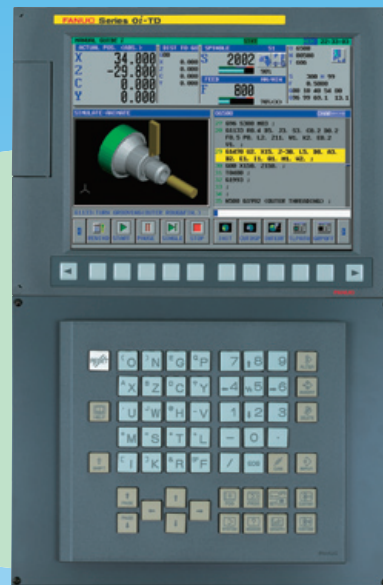

FANUC Series Oi-MODEL D

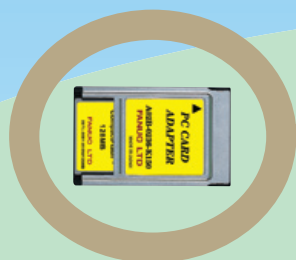

Memory card



FANUC Series Oi Mate-MODEL D

High reliability and high cost-performance Nano CNC

- Packages of the most efficient CNC features
- Leading-edge technology achieves ultra-compact CNC with simplified cables and high-reliability
- Cost-performance oriented configuration with βi series servo
- Network by Embedded Ethernet as basic ^{*2}
- Integrated safety function Dual Check Safety ^{*2}

Enriched control functions

- Basically mounted Nano interpolation enhances surface smoothness
- High-speed, High-precision, High-quality machining with AI contour control and Nano Smoothing ^{*2}
- Suitable for various machines from general machining center / lathe to 2-path lathe ^{*2}
- Machining condition selecting function for achieving desired machining easily

AC SPINDLE MOTOR
 βi series

βi series **SERVO**



SERVO AMPLIFIER
 βi series

AC SERVO MOTOR
 βi series

Cost-performance oriented configuration with βi series servo

AC SPINDLE MOTOR
 βi series

βi series **SERVO**



SERVO AMPLIFIER
 βi series

AC SERVO MOTOR
 βi series

Cost-performance oriented configuration with βi series servo

Excellent operation

- Integrated Operation & Programming Guidance with extremely simplified operations
FANUC MANUAL GUIDE i ^{*2}
- Programming Guidance with extremely simplified operations
FANUC MANUAL GUIDE oi
- Integrated Operation Guidance for NC program-less conventional lathe machining
FANUC TURN MATE i
- Direct editing and operation program in Memory Card

Plenty of customize functions

- C language executor for customizing CNC display and operation ^{*2}
 - FANUC PICTURE for easy creating machine operation screen ^{*2}
- (^{*2} : oi only)

αi series **SERVO**

AC SPINDLE MOTOR
 αi series

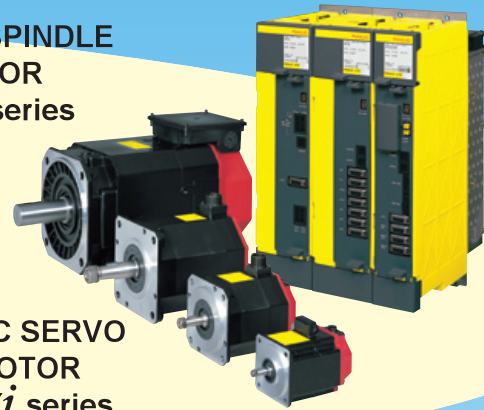

SERVO AMPLIFIER
 αi series

AC SERVO MOTOR
 αi series

The latest servo control functions with αi series servo

Advanced digital servo technology

- SERVO HRV3 Control for high speed and high precision
- SPINDLE HRV3 Control for quick acceleration and response
- “One-shot setting” “One-shot tuning” for powerfully support Startup and Tuning of CNC system
- Quick & smart tuning

FANUC SERVO GUIDE

- Energy saving by power source regeneration, use of latest low loss device and high efficiency of servo & spindle control

Advanced Technology on Hardware

Ultra-Compact CNC with Simplified Cables, High-reliability

Ultra-compact CNC is realized through LCD display with integrated CNC.

A few number cables are provided for ultra high-speed serial communication.

The adoption of ECC technology, which corrects an error during data transfer, realizes further high

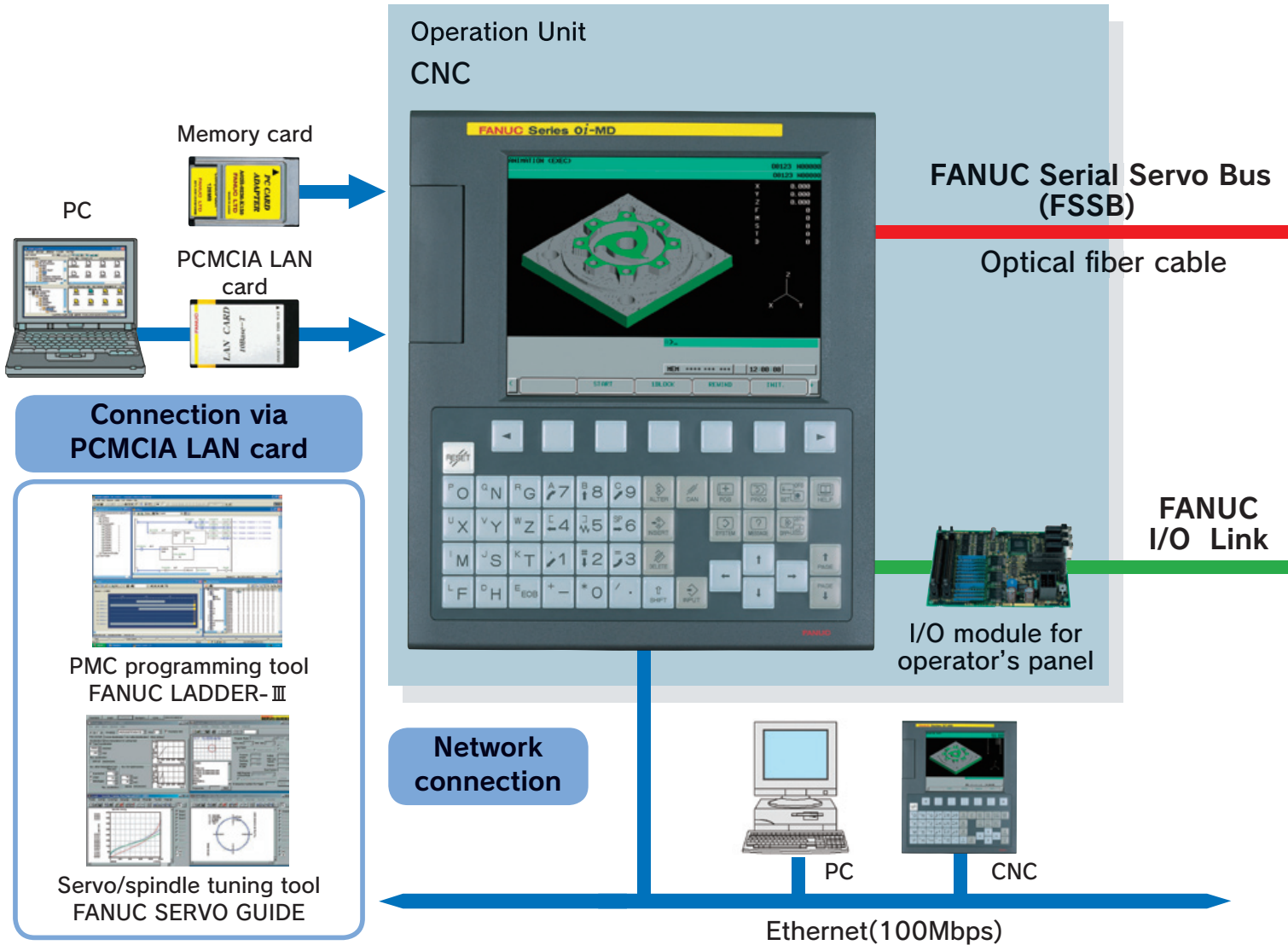

Ultra Compact , Ultra Thin CNC

The small-size CNC integrated with the LCD display realizes the quite thin CNC control unit in depth of 70mm (in case of no optional slot).

High number-crunching Power

Data processing capacity is improved remarkably by the latest high-speed microprocessor. Therefore, this CNC realizes the state-of-the-art features, such as Nano Interpolation, High-Speed & High-precision Machining, Integrated Safety Function and so on, without additional hardware.

High reliability Hardware

Aggressive adoption of ECC (Error Correction Code) technology, which corrects an error generated by the noise, realizes further high reliability.

Embedded Ethernet as basic

Oi only

Series Oi is equipped with Embedded Ethernet as basic. It becomes easy to make a network in factory. The Fast Ethernet board can be mounted as an option.

PCMCIA interface

Easy setup and maintenance operation are available by using PCMCIA interface on the front of LCD display. Memory card editing/operation can be performed with a compact flash card completely stored in the CNC control unit.

- Saving and restoring CNC data with memory card
- Memory card editing/operation
- FANUC LADDER-III and FANUC SERVO GUIDE are available by connecting PC via PCMCIA LAN card.

reliability.

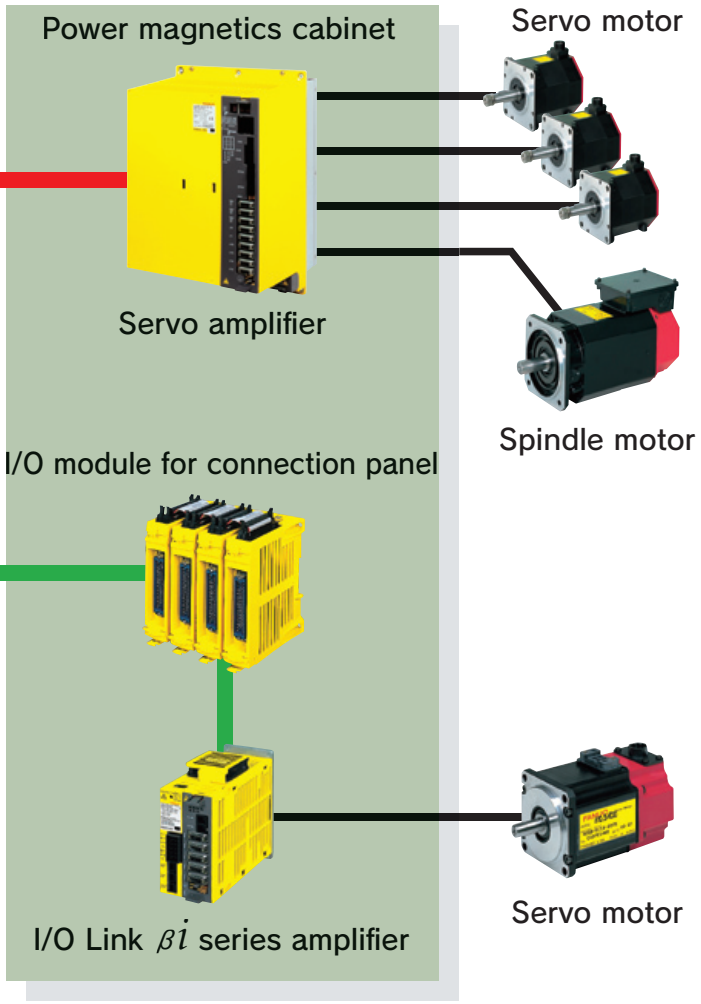

FANUC AC SERVO MOTOR
*βi*s series

High cost-performance AC SERVO MOTOR suited to feed axis of machine tools

Smooth rotation and compact size
Quick acceleration and deceleration
High speed servo motors for live tool added to line-up
Compact and high-resolution *βi* series Pulsecoder

FANUC AC SPINDLE MOTOR
*βi*I series

High cost-performance AC SPINDLE MOTOR suited to spindle axis of machine tools

Achieving high power and high torque with compact size
High efficiency and low heat generation by SPINDLE HRV Control
Achieving the same torque as *βi*I series by *βi*I_P series with smaller amplifier

FANUC SERVO AMPLIFIER
βi SVSP series

High reliability and high cost-performance SERVO AMPLIFIER

High cost-performance all-in-one type amplifier with 3-axis servo and 1-axis spindle
All-in-one structure reducing the number of wiring cables
Line-up with 2-axis servo models and 3-axis servo model
Cs contouring control applied to sensor configuration with *αi* Position coder for position feedback
Energy saving by power source regeneration, use of latest low loss device and high efficiency of servo & spindle control

FANUC Serial Servo Bus (FSSB)

High-speed and noise tolerant optical communication is adopted for the connection between CNC and amplifiers. Moreover FANUC original communication protocol and ECC technology are incorporated. High-reliability and high-speed communication realizes high-performance and simplified cable connecting.

FANUC I/O Link

The FANUC I/O Link is an I/O network used to establish a serial I/O connection with various I/O devices. General-purpose I/O, I/O module for operator's panel, SERVO AMPLIFIER *βi* series for additional axes control and so on can be connected.

Easy maintenance

Detachable fan motor and battery realize further easy maintenance.

Stand-alone type

Oi only

Machine Tool Builder can develop individual and intelligent machine tools by using Stand-alone type Series *Oi*-D combining with PANEL *i* featuring personal computer functions.

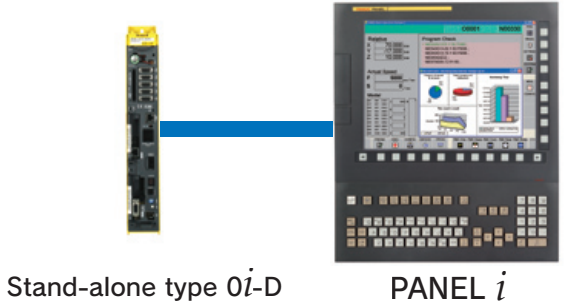

High performance

High-Speed, High-Quality Machining

NANO Interpolation

The NANO interpolation generates position commands for digital servo control in nanometer. This enables smooth path in position commands for digital servo control and enhances surface smoothness.

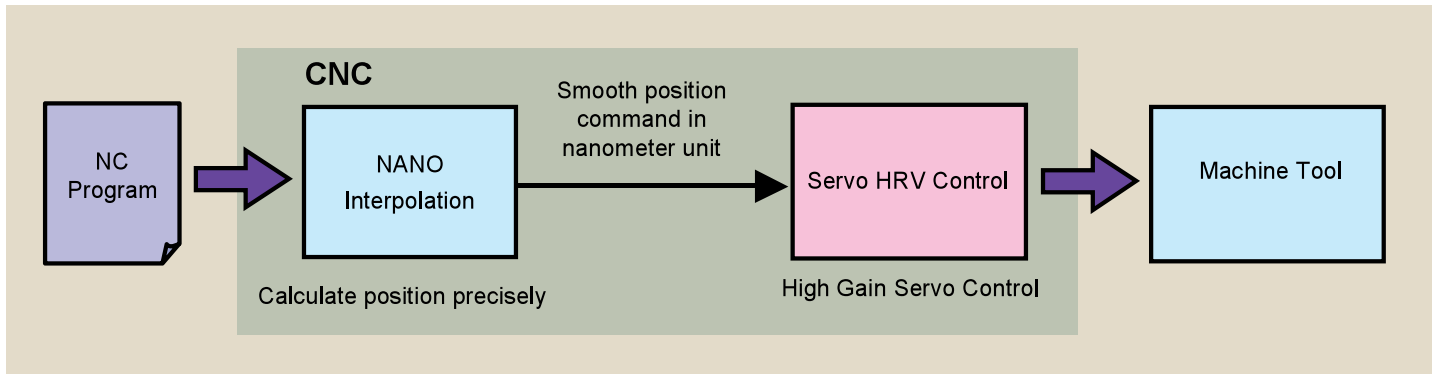

Tapering at an X:Y ratio of 3:1

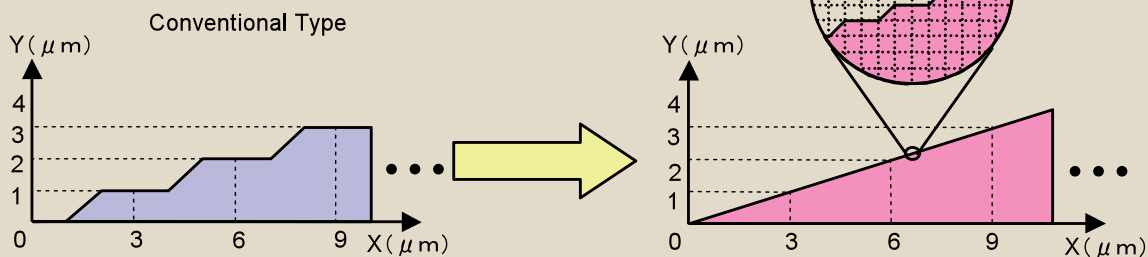

AI contour control

O_i only

AI contour control achieves the optimum feedrate and acceleration/deceleration control by looking ahead multi-blocks of the part program. This can perform high-speed machining of complex free-form curved surfaces of aircraft, automobile parts and metal dies that are specified in continuous small blocks.

Jerk control

O_i only

At a corner which is not sharp but has a large jerk, feedrate can be controlled automatically so that mechanical shock is reduced. And very smooth acceleration/deceleration can be executed. Enhanced smooth motion can reduce mechanical shock to improve surface finish.

Machining condition selecting function

Desired machining can be achieved easily by tuning between highest velocity and highest precision.

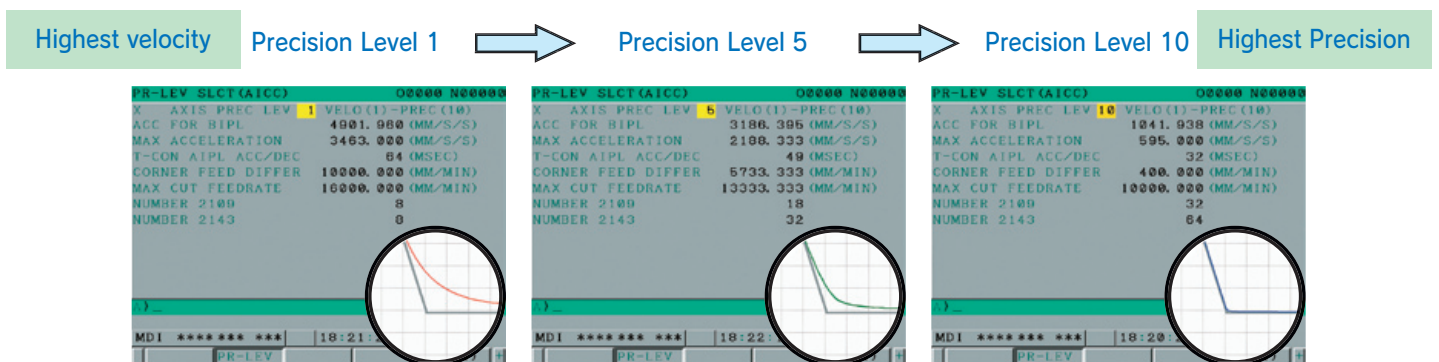

Precision level selection screen

Nano smoothing

Oi only

The desired path is estimated by NURBS curves within a tolerance from minute line command points created by a CAD/CAM system and interpolated in nanometer unit. This gives a smooth machined surface approximate to the designed figure and reduces manual finishing processes.

And a minute line segment program is used, so the previously used programs can be executed without modifications.

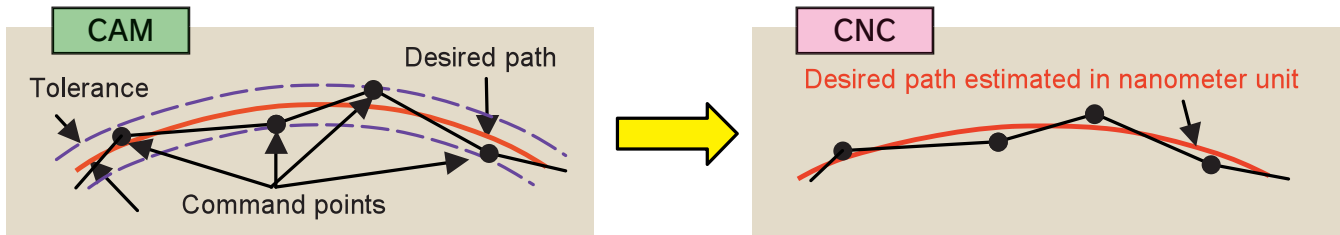

For quality, precision and feedrate level adjustments, machining surface quality level adjustment screen is provided, which is designed so that every user can perform intuitive and easy operations. By using the cursor keys, the user can find the degree of the adjusted level to the current setting at a glance.

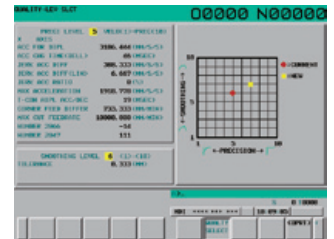

Machining surface quality level adjustment screen

Enriched CNC functions

Spindle control with servo motor

Spindle functions such as rotation command of spindle and rigid tapping etc. are realized by servo motor.

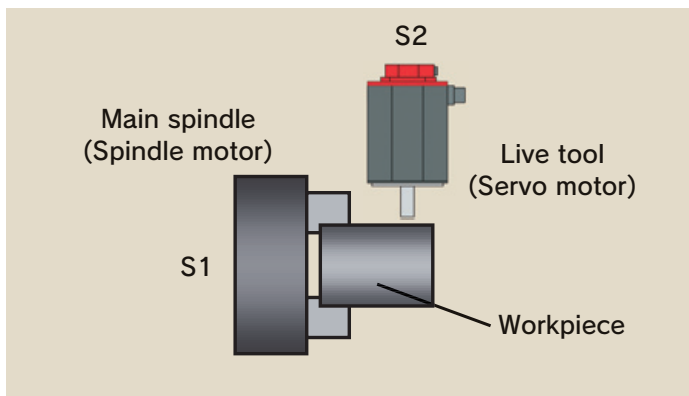

Tool management function

Oi only

A tool management data table for managing a variety of tool data and a cartridge management table for defining the relationships between tool numbers and pot numbers enable the integrated management of tool information.

| NO. | TOOL NO. | POT | TOOL LIFE | REMAINING LIFE | REPLACE | REPLACE | REPLACE |
|-----|----------|-----|-----------|----------------|---------|---------|---------|
| 1 | 0 | 0 | 0 | 0 | 0 | 0 | 0 |
| 2 | 0 | 0 | 0 | 0 | 0 | 0 | 0 |
| 3 | 0 | 0 | 0 | 0 | 0 | 0 | 0 |
| 4 | 0 | 0 | 0 | 0 | 0 | 0 | 0 |
| 5 | 0 | 0 | 0 | 0 | 0 | 0 | 0 |
| 6 | 0 | 0 | 0 | 0 | 0 | 0 | 0 |
| 7 | 0 | 0 | 0 | 0 | 0 | 0 | 0 |
| 8 | 0 | 0 | 0 | 0 | 0 | 0 | 0 |
| 9 | 0 | 0 | 0 | 0 | 0 | 0 | 0 |
| 10 | 0 | 0 | 0 | 0 | 0 | 0 | 0 |
| 11 | 0 | 0 | 0 | 0 | 0 | 0 | 0 |
| 12 | 0 | 0 | 0 | 0 | 0 | 0 | 0 |

Tool management screen

Unexpected disturbance torque detection function

The disturbance torque is detected becoming unexpected level by a machine collision, etc. and axis stops immediately or returns to the opposite direction. This reduces the machine damage.

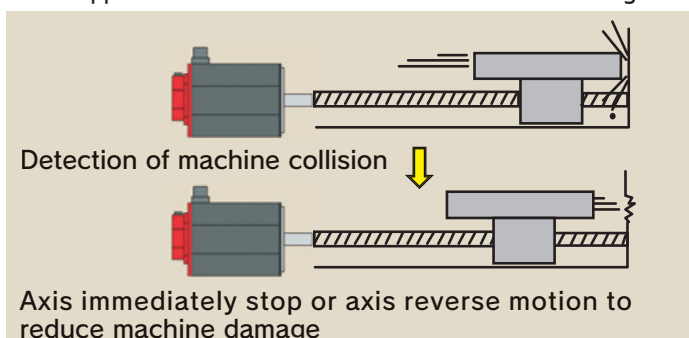

Composite control

Oi only

Move commands can be interchanged between an axis in one path and an axis in the other path.

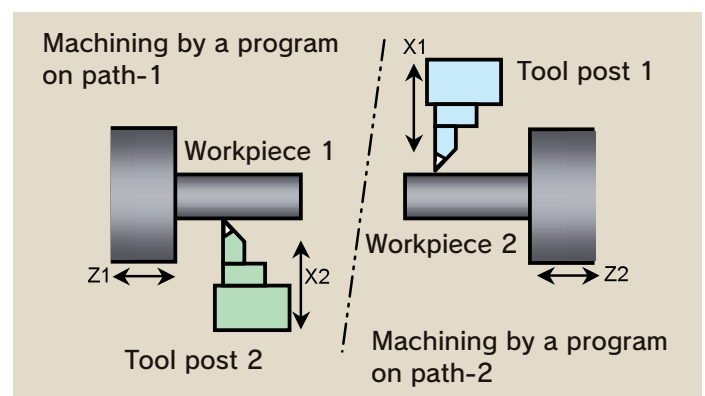

High performance

Advanced digital servo technology

SERVO Motor System

SERVO AMPLIFIER
α1 series



AC SPINDLE MOTOR
α1 series

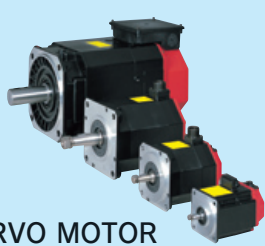

AC SERVO MOTOR
α1 series

αi only

SERVO AMPLIFIER
β1 series



AC SPINDLE MOTOR
β1 series

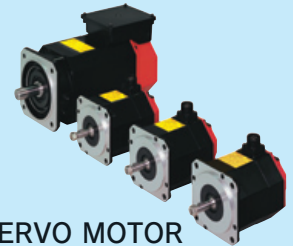

AC SERVO MOTOR
β1 series

SERVO HRV3 Control

High speed and high precision servo control

By combination of hardware technology such as "Servo motor with ultra smooth rotation", "Accurate current detection", "High response and high resolution Pulsecoder", and software technology such as the latest servo control HRV3 (as standard), high speed and high precision control with nano-meter level is ensured. Mechanical resonance can be suppressed by Auto-following HRV filter even though its frequency is changed.

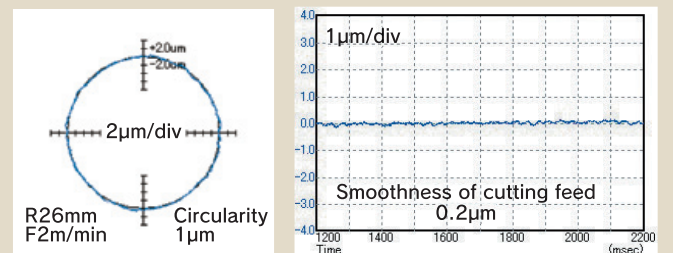

Application example of SERVO HRV3

SPINDLE HRV3 Control

Quick acceleration and response spindle control

High response and high precision spindle control is achieved with fast velocity loop processing and high resolution detector circuit.

In rigid tapping with high response control and feed-forward, reduced synchronous error and shorter cycle time are expected.

Optimum spindle orientation minimizes orientation time, under condition of various load inertia also by making always full use of spindle motor torque.

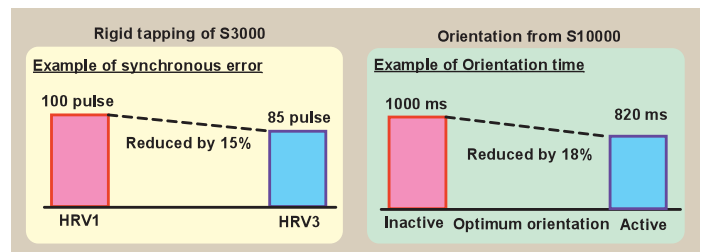

FANUC SERVO GUIDE

Quick & smart tuning of servo and spindle

This software provides the integrated environment for making test programs, setting parameters, and data measurement needed for servo and spindle tuning. It is useful not only for servo tuning but also for the measurement of spindle characteristic.

It has substantial automatic tuning functions for gains filters, and others.

With SERVO GUIDE, quick and smart optimization of servo and spindle can be achieved.

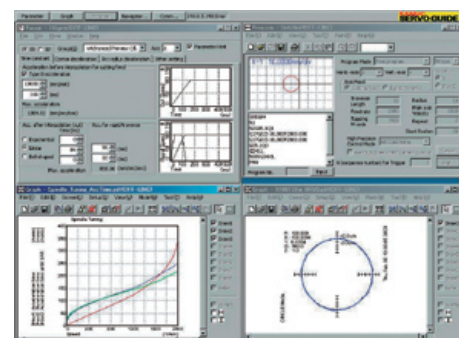

Excellent Operation

User friendly operation and assistance

Program Editing

The CNC program can be edited easily by PC like operation such as cut and paste. The operator can edit the CNC program efficiently. The operating CNC program can be confirmed safely by the reference mode of background editing.

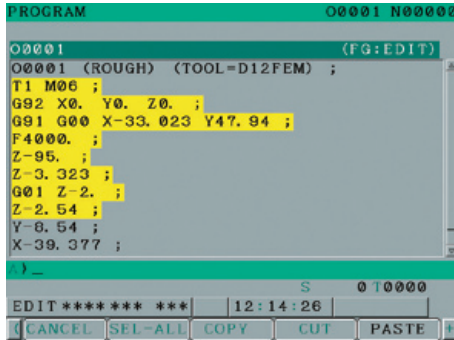

Part program editing screen

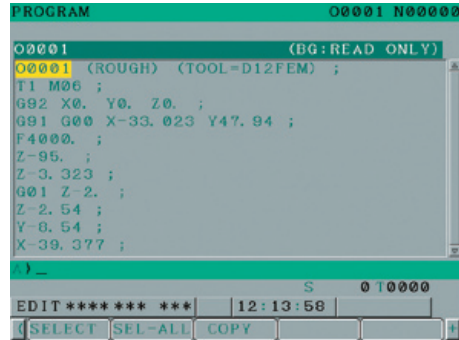

Background editing screen

Memory Card / Data Server Editing · Operation

The programs stored in a memory card and Data Server can be edited by the CNC edit functions and can be executed as well as the programs in built-in CNC program memory. Memory card and Data Server can be used as large-capacity program memory together with built-in CNC memory.

Data Server is for 0i only.

compact flash card

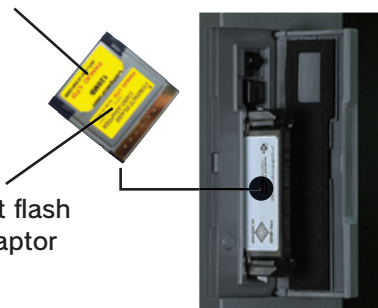

compact flash card adaptor

A compact flash card can be stored in the CNC main unit.

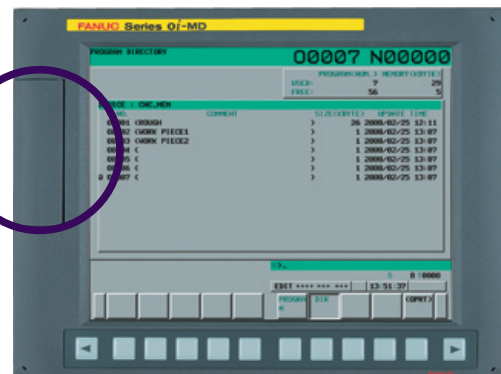

Support of Multiple Languages and Dynamic Display Language Switching

If different operators display in different languages, the display language can be changed to another with a simple operation without turning the power to the CNC off. This function eliminates the need for stopping the machine at the change of operators, which improves work efficiency.

The CNC operation screen supports 18 languages.



Japanese display

Simple operation
 ⇔
 Changed immediately



English display

Excellent Operation

Integrated Operation & Programming Guidance with extremely simplified operations

FANUC MANUAL GUIDE *i*

Oi only

MANUAL GUIDE *i* is an integrated operation guidance, which provides handy operation guidance from programming through machine operation on one single screen. It can be applied to lathe, milling machine and machining center.

- Integrated operating screen
- ISO code part programming
- Powerful program editing functions
- Various machining cycles
- Realistic machining simulation
- Set-up guidance
- Multi-path lathe function

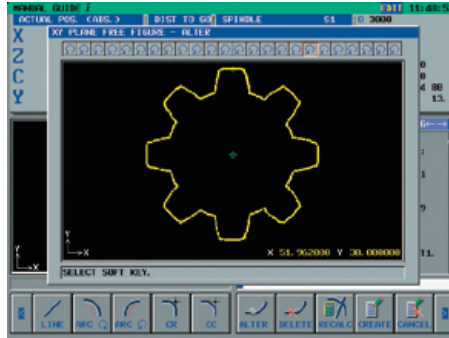

Free figure input screen

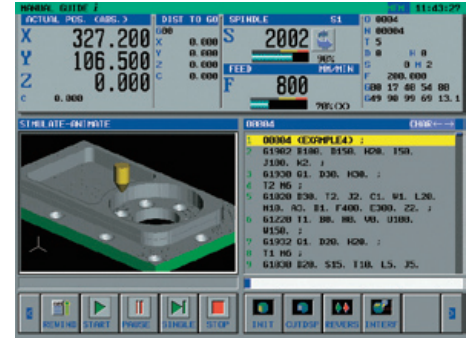

Machining simulation screen

Programming Guidance with various machining cycles

FANUC MANUAL GUIDE *Oi*

MANUAL GUIDE *Oi* is a part programming guidance, which is concentrated to the functionality for creating a part program, and it pursuits the extreme simple operation. It can be applied to lathe, milling machine and machining center.

- ISO code part programming
- G-code and M-code assistance
- Various machining cycles
- Contour programming

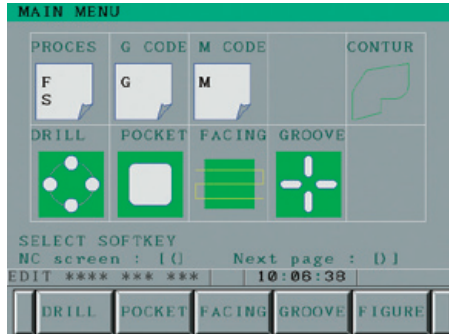

Cycle selection screen

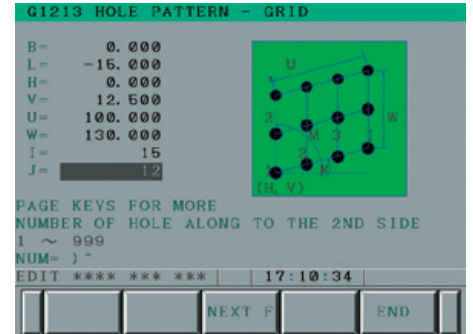

Hole position input screen

Integrated Operation Guidance for NC program-less conventional lathe machining

FANUC TURN MATE *i*

TURN MATE *i* has accomplished NC program-less turning operation for conventional lathe. It is possible to carry out turning easily only by following guidance on screen and inputting data.

- Plain all in one screen
- Application to display with and without touch panel
- Various machining cycles
- Sequential execution of machining cycles (Max. 20)
- NC program conversion function of machining cycles

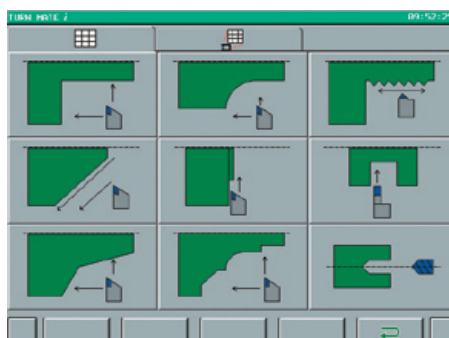

Cycle selection screen

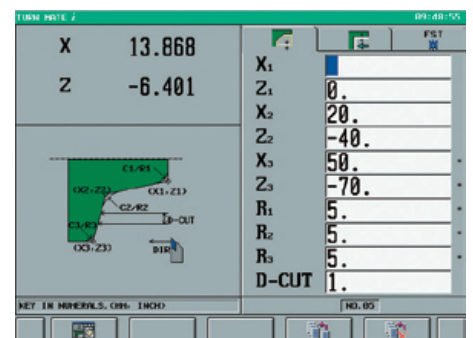

Cycle data input screen

Network Support Functions

With plenty of network functions, you can construct an optimum system for CNC machine tools

High-speed Ethernet

Oi only

Embedded Ethernet of 100 Mbps is supported as a basic function. CNC can be connected to a personal computer to transfer NC programs and monitor CNC status.

The Fast Ethernet board can be mounted as an option. Data can be transferred simultaneously among multiple computers at a high speed. These features are suited to construct a production system which exchanges information among machining lines and factory host computer.

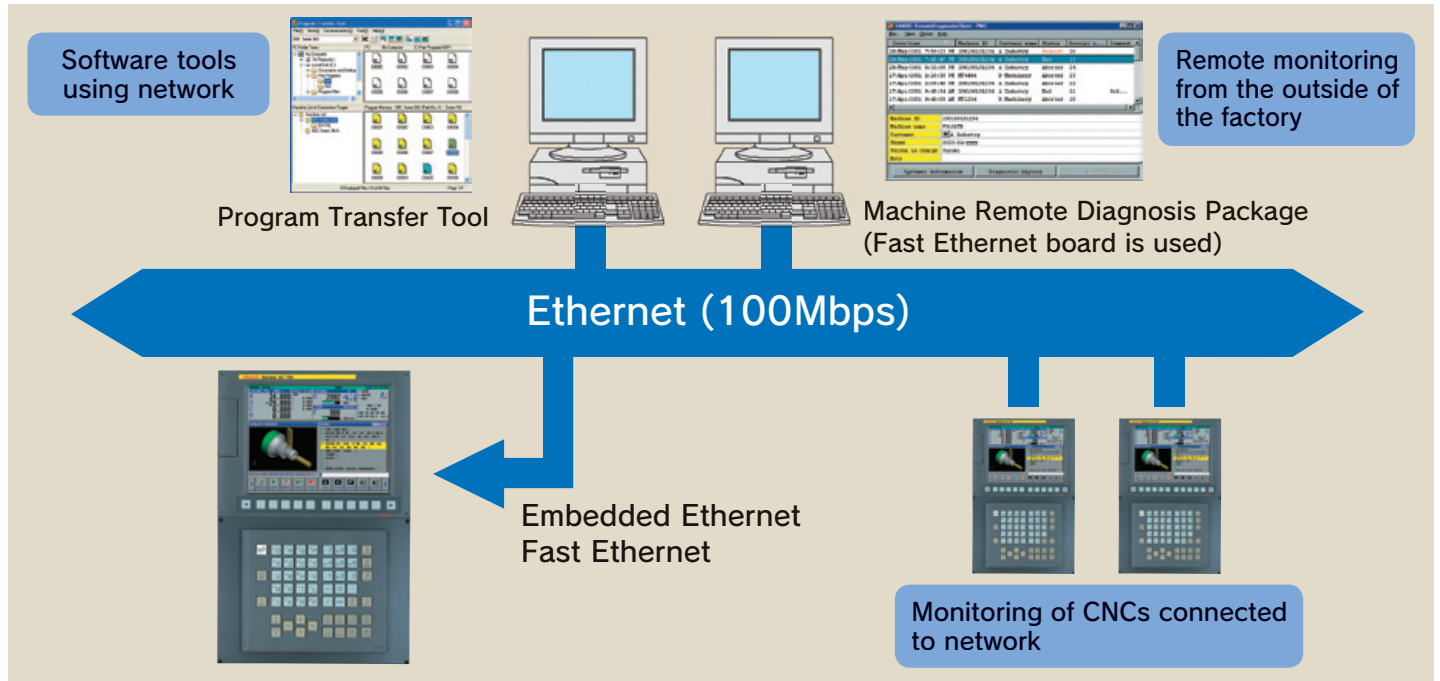

Fast Data Server

Oi only

NC programs can be stored in the built-in compact flash card in the Fast Data Server for high-speed machining. Other Ethernet functions can be used simultaneously with operation with the Data Server.

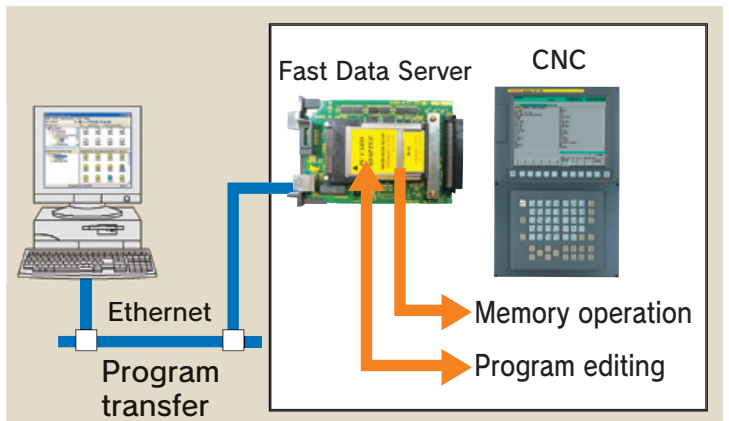

- High speed transfer between Data Server and PC
- Up to 4 G bytes capacity for storing NC programs
- Memory operation and program editing

Field network

Oi only

The following field networks are supported, which allows user-specified system construction and peripheral incorporation.

- FL-net
- PROFIBUS-DP(Master/Slave)
- DeviceNet(Master/Slave)

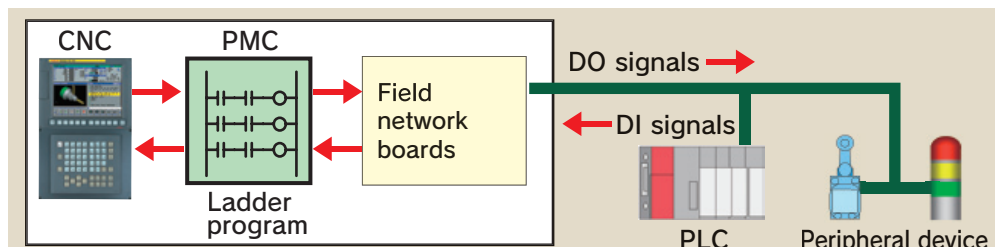

Powerful built-in PMC

Built-in PMC function

High-speed and large capacity ladder

The large capacity built-in PMC, with Max. 32,000 ladder steps for *Oi* or Max 8,000 ladder steps for *Oi* Mate, is available for complex sequence control of machine and peripheral devices. The PMC and the CNC are connected with high-speed internal bus closely and this enables to transfer various data between PMC and CNC at a high speed.

Extended PMC Ladder Instruction function

The enhanced computation instructions enable to program complex sequence control of machine into a simple ladder circuit with high readability. The new function helps reduce redundant descriptions of relay contacts and coils, thereby reducing the number of nets and steps of ladder program. The enhanced PMC function enables to correspond flexibly to an abundant array of machine sequence control requirements and realizes efficient ladder development and maintenance by machine tool builders.

Function Block function

This function enables to call up repeatedly used ladder circuit patterns in blocks. By combining multiple Function Blocks, machine tool builders can create complex ladder programs more efficiently, as if assembling components, with fewer steps for ladder program development and fewer ladder diagram drawings for maintenance.

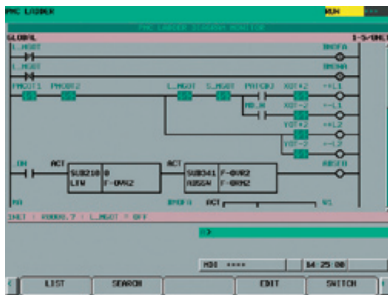

Extended PMC Ladder Instruction function

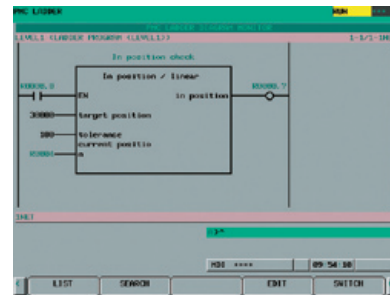

Function Block function

Positive Safety Measures

Dual Check Safety

Oi only

Dual Check Safety, incorporated into the CNC, is a safety function that conforms to the international safety standard (IEC 61508 SIL2).

This function offers a high level safety by using multiple microprocessors that redundantly monitor the actual servo motor position/speed, the actual spindle speed and safety-related input/output and by providing duplicate paths of breaking power for the servo/spindle amplifier.

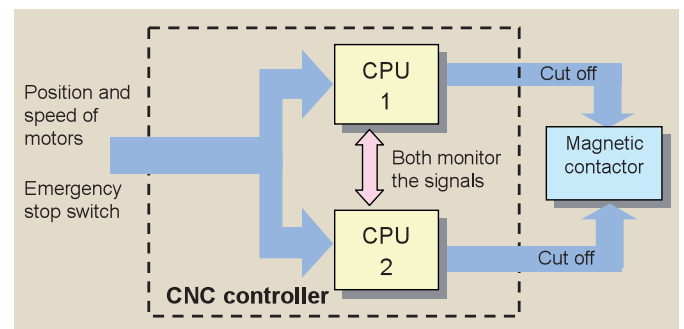

Prevention of Operator Errors

Various types of checks are made and many confirmation messages are displayed for CNC operation, which prevents unintentional operator errors from occurring.

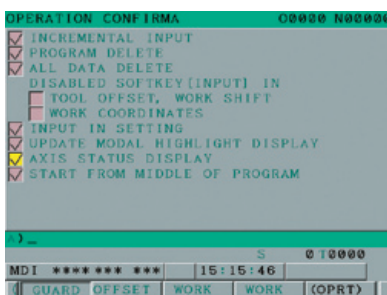

Setting Screen

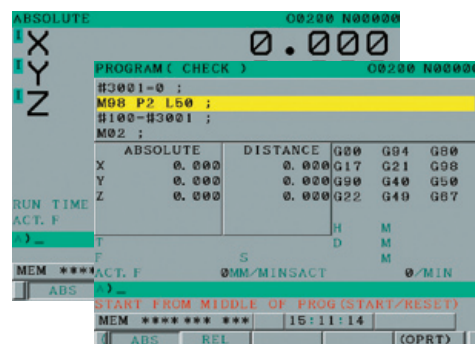

Axis status display and reconfirmation of program start

Plenty of Customize Functions

Customize the machine tools uniquely

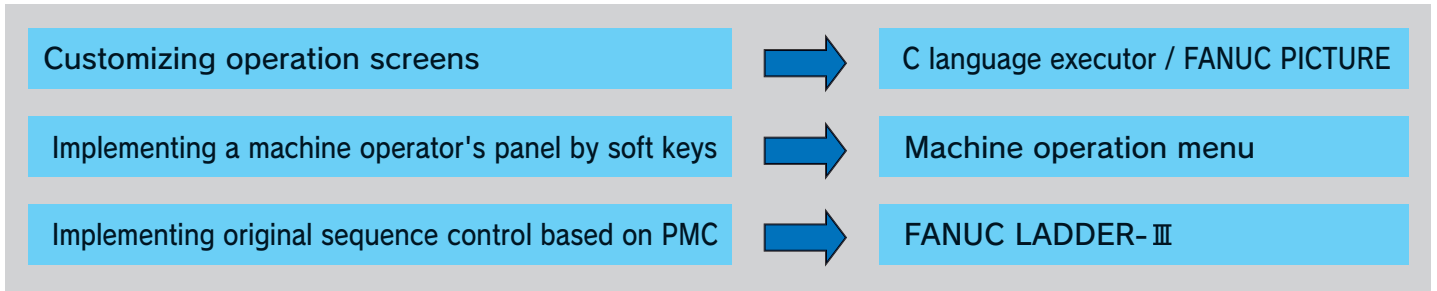

C language executor

Oi only

Machine tool builders can create their own operation screens, which enables unique CNC display and operation.

- C language is used for programming.
- Operation screens using the touch panel can be created.
- In addition to standard ANSI functions, many functions are available for CNCs and PMCs.



FANUC PICTURE

Oi only

FANUC PICTURE enables a machine operation screen to be created only by pasting screen components such as buttons and lamps on the personal computer.

- An easy-to-use user interface that is unique to FANUC and close to the operability of Visual Basic is provided.
- A screen usable on a display unit with and without a touch panel can be created.
- A created screen is executed by the C language executor.

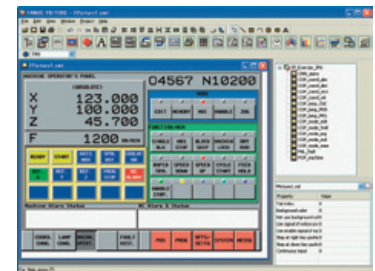

Machine operation menu

Oi only

The machine operator's panel can be implemented by the CNC soft keys. This makes the operator's panel more compact and machine functions can be easily added or changed.

- A hierarchical menu can be structured and a maximum of 210 buttons can be created.
- The machine operation menu can easily be created using the definition file without special programming.

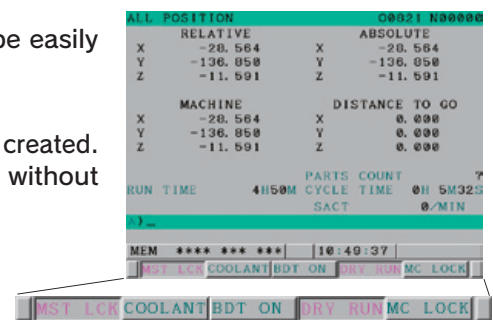

FANUC LADDER-III

For machine customization, a machine tool builder's own sequence control can be incorporated into the built-in PMC. A PMC sequence program can be created on the personal computer by using FANUC LADDER-III, the highly easy-to-use programming tool with many useful functions.

- A program can be created with ladder and function block.
- A program can be coded using signal names instead of signal addresses.
- Online monitoring and editing can be performed by connecting the personal computer with the CNC via Ethernet. (PCMCIA LAN card is necessary to connect with Oi Mate.)

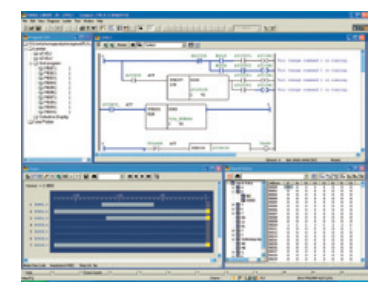

Easy Setup and Maintenance

Powerfully support Startup and Tuning of CNC system

Parameter Setting Support Screen

Parameter Setting Support Screen powerfully supports the necessary parameter setting for start-up and adjustment of CNC, Servo and Spindle. In menu screen, various setting and adjustment screens are selected by the cursor operation, and the parameter is set on each screen.

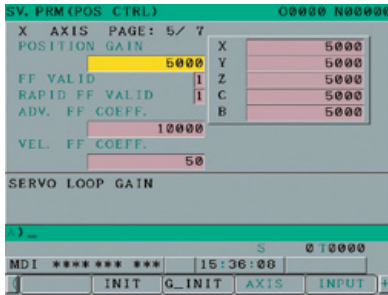

Servo parameter setting screen

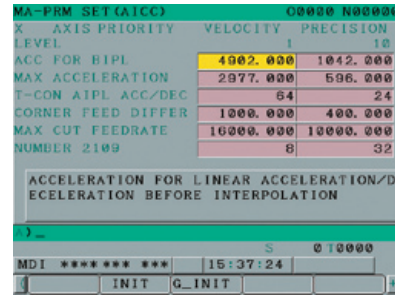

Machining parameter setting screen

“One-shot setting” for Servo axes and “One-shot tuning” of Velocity gain

The recommended parameters for high speed and high precision machining can be set only by pressing soft-key once. Practically enough precision can be achieved with only this “One-shot setting”.

If higher precision is required, stable and optimum velocity gain for each machine can also be set automatically by only pressing soft-key for Parameter Tuning of Velocity Gain.

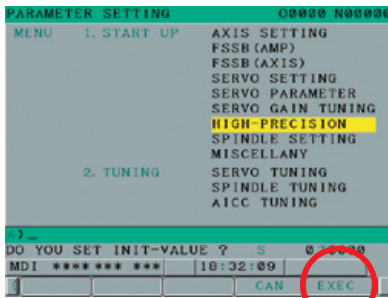

Menu screen

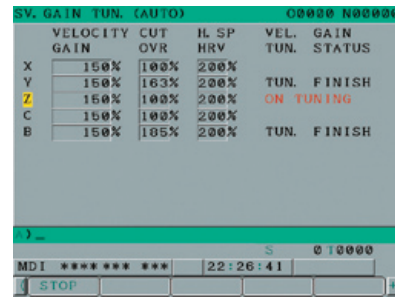

Velocity gain tuning screen

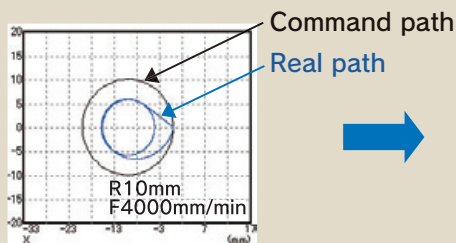

Radius shrinkage 4mm

Before applying
 Parameter Setting for High Precision

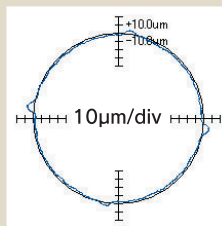

Protrusion 6µm

After applying
 Parameter Setting for High Precision

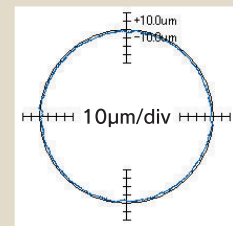

Protrusion 3µm

After applying
 Parameter Tuning of Velocity Gain

“One-shot setting” for Spindle axes

The initial parameters for start-up of spindle can be set by “One-shot setting”. The necessary parameters are set automatically by inputting spindle configuration items, such as motor model, maximum speed, sensors.

This screen supports the initial setting also for the optimum orientation function and the parameters for high speed rigid tapping.

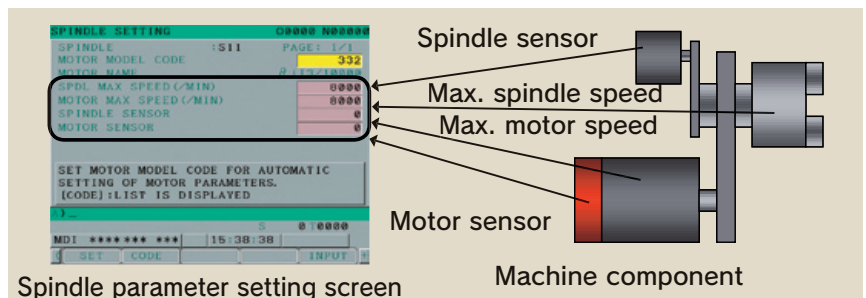

Spindle parameter setting screen

Machine component

Powerful Software Tools

Support development of machine tool builders in a variety of fields such as simulation and data management

Simulation Tools Supporting Utilization of High-Level CNC Functions

Software tools for CNC operation simulation on the personal computer are provided to fully utilize the ever advancing CNC functions. Two types of packages are available to meet applications:

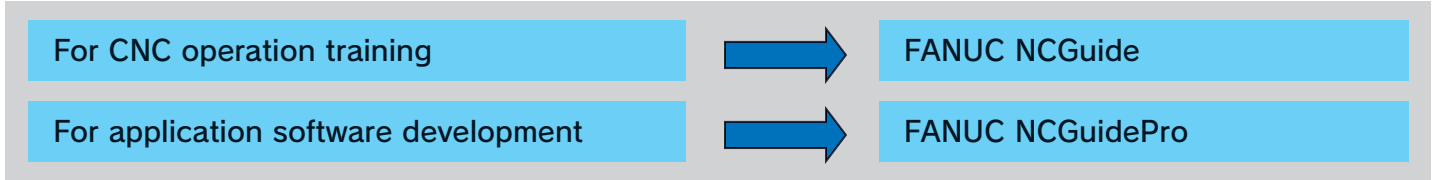

FANUC NCGuide (Training tool that enables learning of CNC / MANUAL GUIDE *i* operations)

The FANUC NCGuide is a software tool that enables training of CNC/MANUAL GUIDE *i* operations on the personal computer without using an actual CNC. This software tool allows operators to be trained without using an actual machine tool. This software tool can also be used for CNC training in school.



- CNC and MANUAL GUIDE *i* training is possible.
- Machining programs and machining cycles can be edited in the EDIT mode.
- Machining simulation (animated simulation and tool path drawing) is possible.

FANUC NCGuidePro (Development tool that supports PMC ladder and customized software debugging)

The FANUC NCGuidePro is a development support tool that enables ladder to be executed on the personal computer. Moreover, the C language executor and macro executor can be executed, so that this development support tool can be used to debug a custom screen created by a machine tool builder.

- PMC ladder can be executed on PC.
- Ladder debugging operation interacting with the CNC simulation is enabled.
- Ladder editing and display interacting with FANUC LADDER-III are possible.
- PMC axis control simulation is possible.
- Customized software created with FANUC PICTURE, C language executor, or macro executor can be executed.

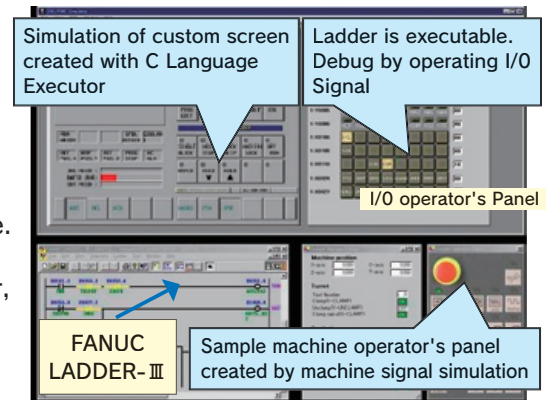

FANUC Program Transfer Tool

FANUC Program Transfer Tool is a software tool for transferring part programs and data by connecting PC and CNC via Ethernet.

Files in the CNC program memory are displayed on the tool in an easy-to-understand way, so input/output operation can be easily performed with a mouse.

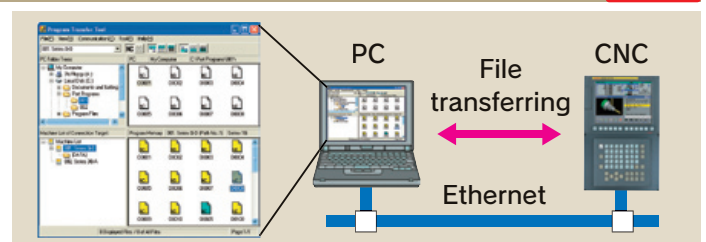

FANUC CNC Setting Tool

FANUC CNC Setting Tool is a software tool used to set and manage CNC parameters on a personal computer. Parameters can be set and managed efficiently without referring to the manual.

- Parameters are classified by the CNC function.
- Detailed explanation is displayed by selecting a parameter.
- CNC parameter is transmitted via Ethernet or memory card.

Maintenance and Customer Support

Worldwide Customer Service and Support

FANUC operates customer service and support network worldwide through subsidiaries and affiliates. FANUC provides the highest quality service with the prompt response at any location nearest you.

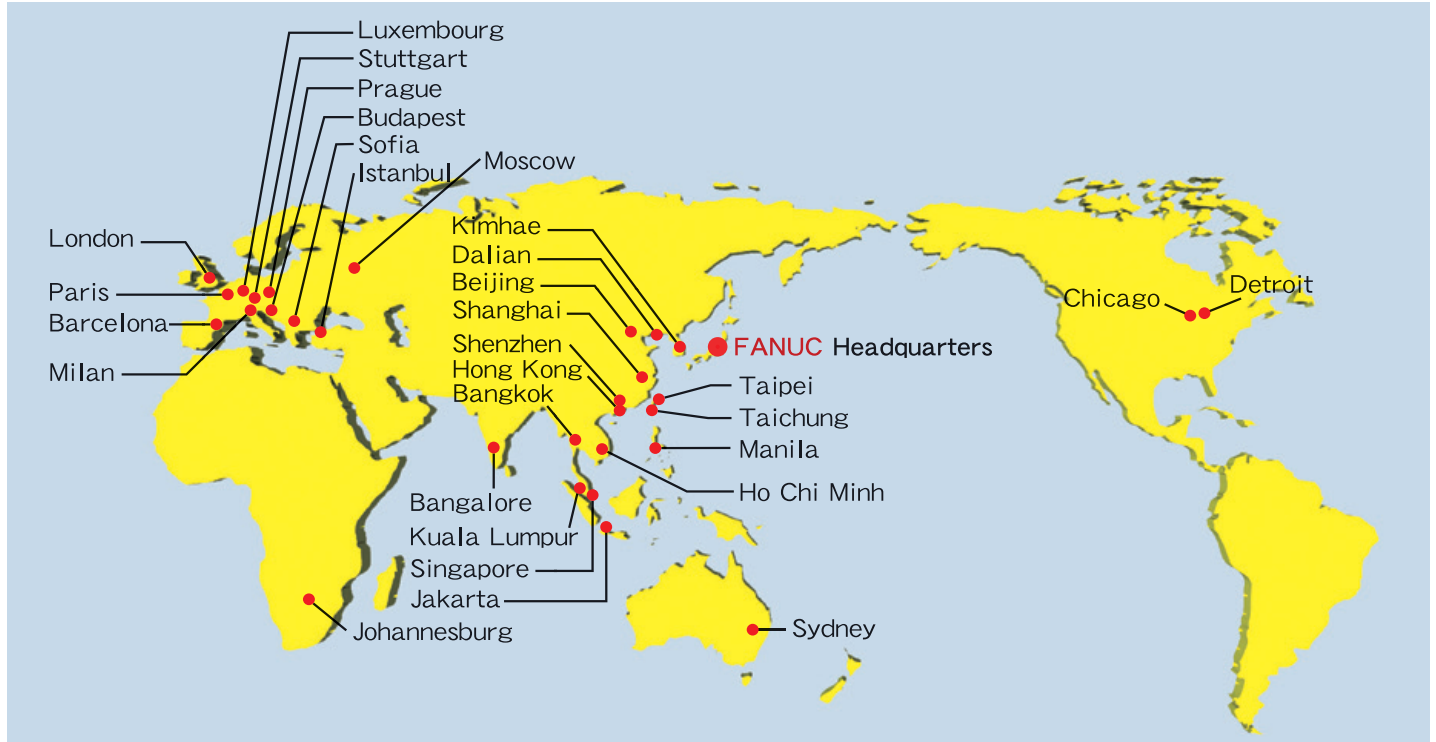

FANUC Training Center

FANUC Training Center operates versatile training courses to develop skilled engineers effectively in several days.

Inquiries : Yamanakako-mura, Yamanashi,
Japan 401-0501

Phone : 81-555-84-6030

Fax : 81-555-84-5540



FANUC LTD

Headquarters Oshino-mura, Yamanashi 401-0597, Japan Phone: 81-555-84-5555 Fax: 81-555-84-5512 <http://www.fanuc.co.jp>

• America

FANUC CNC AMERICA CORPORATION

Tel 1-847-898-5000

Fax 1-847-898-5001

• Europe, the middle east and Africa

FANUC CNC EUROPE GmbH
FANUC GERMANY SERVICE GmbH
FANUC FRANCE SERVICE S.A.S
FANUC U.K. SERVICE LIMITED
FANUC ITALIA SERVICE S.p.A.
FANUC IBERIA SERVICE S.A.
FANUC TURKEY SERVICE LTD
FANUC BULGARIA SERVICE CORPORATION
FANUC CZECH SERVICE s.r.o.
FANUC HUNGARY SERVICE Kft
FANUC SOUTH AFRICA (PROPRIETARY) LIMITED
"FANUC AUTOMATION" LLC

Tel 49-7158-187100
Tel 49-7158-187300
Tel 33-1-4569-6333
Tel 44-1895-634182
Tel 39-02-4887-291
Tel 34-93-664-4820
Tel 90-216-3913548
Tel 359-2-963-3319
Tel 420-234-072-950
Tel 06-23-507-400
Tel 27-11-392-3610
Tel 7-495-956-9780

Fax 49-7158-187111
Fax 49-7158-187411
Fax 33-1-4569-0325
Fax 44-1895-676140
Fax 39-02-4571-3566
Fax 34-93-665-0695
Fax 90-216-3918133
Fax 359-2-963-2873
Fax 420-234-072-960
Fax 06-23-507-401
Fax 27-11-392-3615
Fax 7-495-956-9785

• Asia and Oceania

FANUC KOREA CORPORATION
FANUC TAIWAN LIMITED
BEIJING-FANUC Mechatronics CO., LTD.
FANUC INDIA PRIVATE LIMITED
FANUC THAI LIMITED
FANUC MECHATRONICS (MALAYSIA) SDN. BHD.
PT. FANUC INDONESIA
FANUC SINGAPORE PTE. LTD.
FANUC OCEANIA PTY. LIMITED
FANUC PHILIPPINES CORPORATION
FANUC VIETNAM LIMITED

Tel 82-55-346-0122
Tel 886-4-2359-0522
Tel 86-10-6298-4726
Tel 91-80-2852-0057
Tel 66-2-662-6111
Tel 60-3-7628-0110
Tel 62-21-4584-7285
Tel 65-6-567-8566
Tel 61-2-8822-4600
Tel 63-2-891-3313
Tel 84-8-824-6638

Fax 82-55-346-2548
Fax 886-4-2359-0771
Fax 86-10-6298-4741
Fax 91-80-2852-0051
Fax 66-2-662-6120
Fax 60-3-7628-0220
Fax 62-21-4584-7288
Fax 65-6-566-5937
Fax 61-2-8822-4666
Fax 63-2-891-3315
Fax 84-8-824-6637

• All specifications are subject to change without notice.
• No part of this catalog may be reproduced in any form.
• The products in the FANUC Series 0i-MODEL D/FANUC Series 0i Mate-MODEL D listed in this catalog are not subject to Items 2 to 15 in the Attachment to the Foreign Exchange Order of the "Foreign Exchange and Foreign Trade Law" but are subject to Item 16 (catch-all controls). The export from Japan may be subject to an export license by the government of Japan.
Further, re-export to another country may be subject to the license of the government of the country from where the product is re-exported. Furthermore, the product may also be controlled by re-export regulations of the United States government.
Should you wish to export or re-export these products, please contact FANUC for advice.