



Made to specification on the shopfloor.



Made to specification for the shopfloor.

# SINUMERIK 828D

Answers for industry.

**SIEMENS**



## Contents

Hardware	03 – 07
Applications	08 – 09
CNC functions	10 – 13
Operation, programming, technology	14 – 21
Communication	22 – 23
Service and commissioning functions	24 – 25
Drives and motors	26 – 27
PLC, system overview, accessories	28 – 29
Technical information	30 – 31



**Enabled for communication:**

- Front ports (IP65 degree of protection)
- RJ45 Ethernet
  - USB 2.0
  - Compact Flash (CF) Card

**Heavy duty:**

Panel front made from die-cast magnesium

**Optimal view:**

10.4" TFT color display

**Scalable sturdy CNC operator panel:**

- Two versions with different performance capabilities
- PPU 260/261
  - PPU 280/281



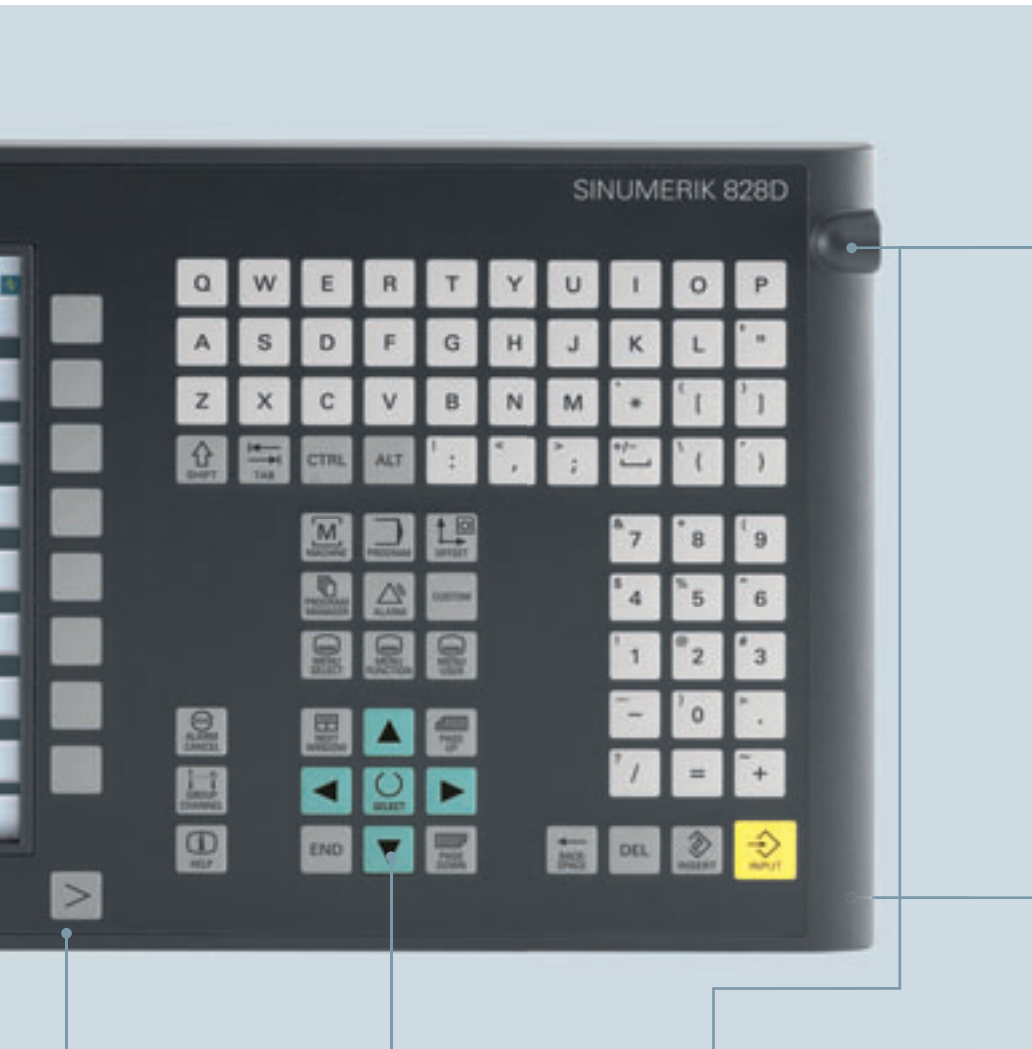

**Low-maintenance:**

- No battery (non-volatile data buffer thanks to NV-RAM technology)
- No hard disk
- No fan

**User-friendly:**

- Full QWERTY keyboard
- Hard keys with protective foil
- IP65 degree of protection

**Clever:**

3/8" thread for additional components

**Optimally connected:**

- Rear side ports
- USB 2.0
  - RJ45 Ethernet
  - DRIVE-CLiQ
  - PLC I/O Interface
  - RS 232 C
  - NC inputs/outputs

Compact, strong, simple...  
...simply perfect!



By devising the SINUMERIK 828D, we have managed to develop a panel-based CNC that is tailor-made for use in milling and turning machines. The product combines CNC, PLC, operating and axis control functions for six CNC measuring circuits into one compact unit, which is designed to fit any operator panel housing. Despite its compact dimensions, the SINUMERIK 828D is a real powerhouse. Equipped with premium CNC functions such as the ability to execute kinematic transformations or powerful tool management, the product leaves nothing to be desired...and all without being unnecessarily complicated. The SINUMERIK 828D is ideal for the shopfloor thanks to its unique graphical user interface. Users can quickly commission, operate, program, service and maintain machines and tasks without the need for extensive training.

# SINUMERIK 828D: One system, two versions, many advantages.

Dimensions (W x H x D): 483 x 220 x 105 mm



The SINUMERIK 828D is available in two versions that offer different performance levels, which means it can be perfectly adapted to suit the power requirements of the machine. There are separate software versions for milling and turning applications. These provide the maximum possible number of machine presets, thereby helping to keep commissioning times to a minimum.

## Enabled for communications

The SINUMERIK 828D is equipped with all the latest communications ports. The Compact Flash (CF) Card, USB and service ports are located behind the flap on the operator panel front, from where they can be directly accessed. The flap can even be closed once a CF Card has been inserted.

## Heavy duty

The operator panel front of the SINUMERIK 828D is made from heavy duty die-cast magnesium. This ensures that the SINUMERIK 828D remains in good condition even if subjected to harsh operating conditions. The hard keys on the CNC keyboard are covered in embossed foil to provide perfect protection against moisture.

## Compact and user-friendly

Thanks to its mounting dimensions, the SINUMERIK 828D can even be built into highly compact operator panel housings. Despite its small dimensions, the SINUMERIK 828D features a 10.4" color display along with a full QWERTY keyboard and offers maximum user-friendliness.

Dimensions (W x H x D): 310 x 380 x 105 mm



### Low-maintenance

The SINUMERIK 828D has no hard disk and no fan. Thanks to the removal of these parts, which are subject to wear, the SINUMERIK 828D is relatively easy to maintain and easy to service. In addition, no battery is required and the use of NV-RAM does away with the need for backup.

### Scalable

The SINUMERIK 828D is available with both a horizontal and a vertical operator panel layout. Both operator panel orientations are available in conjunction with two different performance ratings. As a result, the SINUMERIK 828D can be perfectly matched to the installation location as well as the power requirements.

### Versions of the SINUMERIK 828D

#### Standard version

PPU 260 (vertical operator panel layout)  
PPU 261 (horizontal operator panel layout)

#### Performance version

PPU 280 (vertical operator panel layout)  
PPU 281 (horizontal operator panel layout)

# Milling machines: Setting up and getting started.



The SINUMERIK 828D is perfect for equipping vertical and straightforward horizontal milling centers featuring up to six CNC measuring circuits. And thanks to the new Advanced Surface motion control function it can also be used in tool- and moldmaking applications.

## **Straightforward operation. Across the board.**

As well as being suitable for use with milling spindles and geometry axes (X-, Y-, and Z-axes), the CNC can be used to operate other machine units as an alternative.

These include:

- CNC rotary table (C-axis) for machining on two stations
- CNC reversible clamping device (A-axis) for milling and hole machining on cylindrical workpieces
- CNC gantry axes (gantry operation)
- Inclined heads or swivel tables for milling and hole machining in statically rotated machining planes
- CNC-controlled tool changer



# Turning machines: Guaranteed to turn out well.

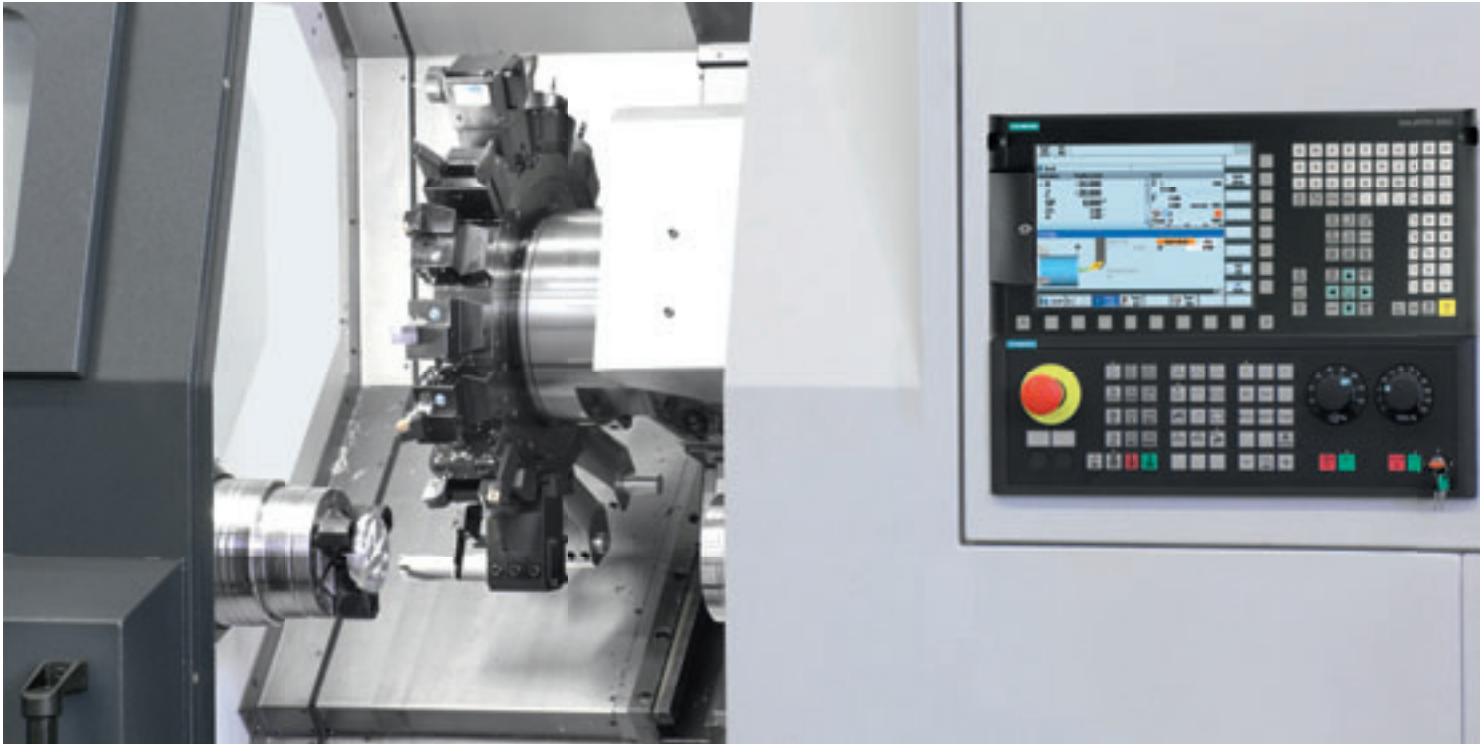

Another application for the SINUMERIK 828D is the control of turning machines. The functional scope has been tailored for horizontal and vertical turning centers equipped with one machining channel and up to eight CNC measuring circuits.

## Flexible use

Besides being suitable for use with lathe spindles and geometry axes (X- and Z-axes), as an alternative the product can be used to operate other machine units:

- Power tools, peripheral C-axis mode, and Y-axis (orthogonal or diagonal) for end face and surface machining
- Counterspindle with synchronous spindle function for two-sided workpiece machining
- Tailstock axis (with travel to fixed stop function)
- CNC-controlled turret

# Accuracy: This compact powerhouse is raising the bar.

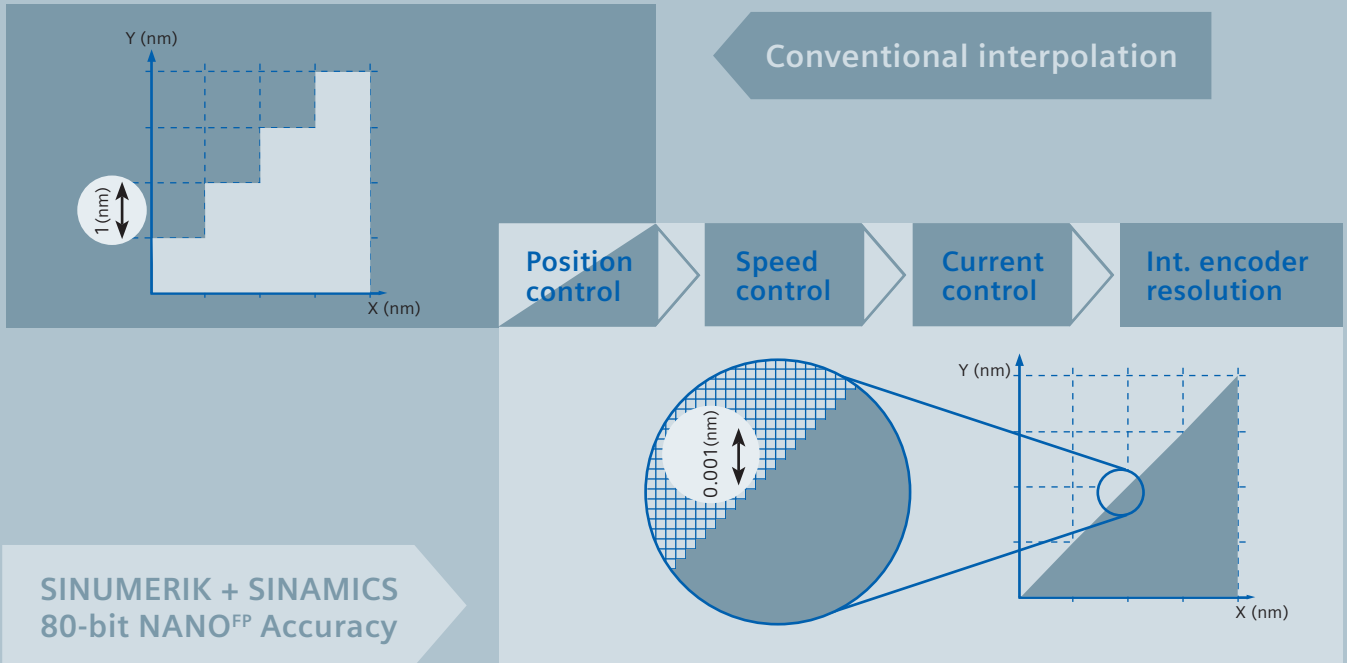

Workpiece accuracy is not just determined by the machine's mechanical system. The CNC also contributes significantly to the precision of the workpieces produced. The SINUMERIK 828D, a real powerhouse among compact CNCs, offers a variety of top-notch CNC functions to ensure the necessary precision.

## The ultimate in accuracy

SINUMERIK and SINAMICS are equipped with 80-bit NANO<sup>FP</sup> Accuracy. As a result, accuracy of well under a nanometer can be achieved. This precision is not just available for closed-loop position control but also for current regulation and closed-loop speed control, as well as within the context of drive sensor evaluation.

## Easy on mechanical systems

Your machine's mechanical system is protected thanks to an intelligent jerk limitation feature. Smooth acceleration and deceleration prolong the service life of the machine, thereby increasing its productivity.

## Maximum contour precision

Thanks to the dynamic feedforward control feature, following errors in the machine can be calculated as early as set point output and compensated for in advance. This way, maximum contour precision can be achieved.

## Deviation detection

Contour deviations can be almost completely eliminated during axis reversal thanks to the integrated quadrant error compensation feature. This results in a perfect workpiece surface, even at the kinds of critical quadrant transitions that are associated with circular paths. Naturally, the SINUMERIK 828D also compensates for mechanical inaccuracy in the ball screw.

## Integrated thermal compensation

The integrated thermal compensation feature balances out any potential temperature changes in the machine and ensures constant workpiece precision.

# Advanced Surface technology: Unique performance for moldmaking workpieces.

Conventional CNC

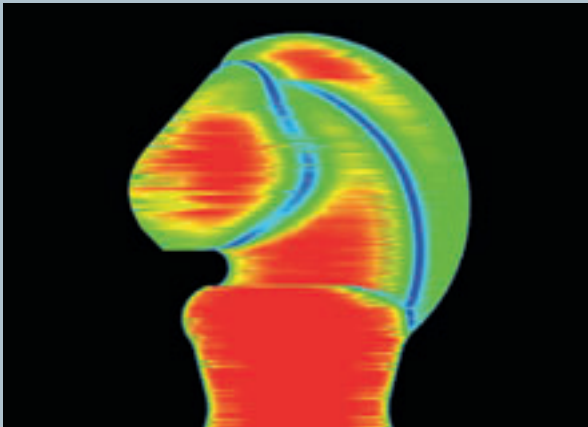

Machining time: 48 min.



Velocity

with Advanced Surface

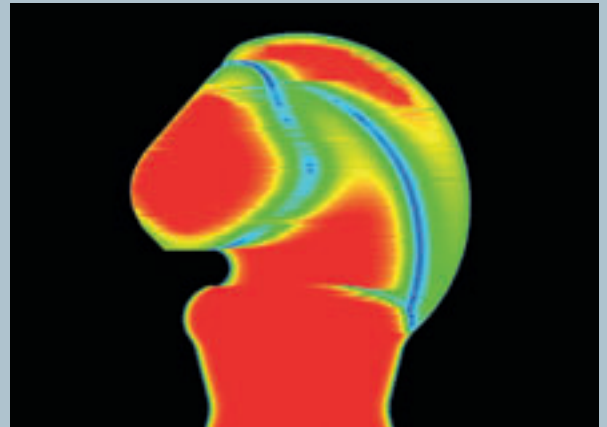

Machining time: 33 min.

The manufacture of moldmaking workpieces has always been one of the biggest challenges for a CNC. The SINUMERIK 828D is able to rise to this challenge thanks to its Advanced Surface technology, a unique method of calculation which aims to improve workpiece surfaces while significantly reducing machine time.

## Perfect surfaces

The SINUMERIK 828D can even cope with inadequate CNC block sequences in mold-making programs. Innovative "look-ahead" mathematical algorithms calculate the forwards and backwards path motions identically. In this way, perfectly smooth workpiece surfaces can be achieved when carrying out line-by-line milling for molds.

## Minimal machining time

Advanced Surface technology guarantees the shortest possible machining times, as well. A completely new kind of motion control is able to calculate optimum smoothing of the surface, thereby ensuring that the tool remains within the optimum speed range at all times.

## Only needs to be optimized once

The system needs to be optimized only once in order for the tolerant filter algorithms that form part of the Advanced Surface technology to guarantee optimum workpiece surfaces and the shortest possible machining times.

# Transformations: Full orientation in all machining planes.

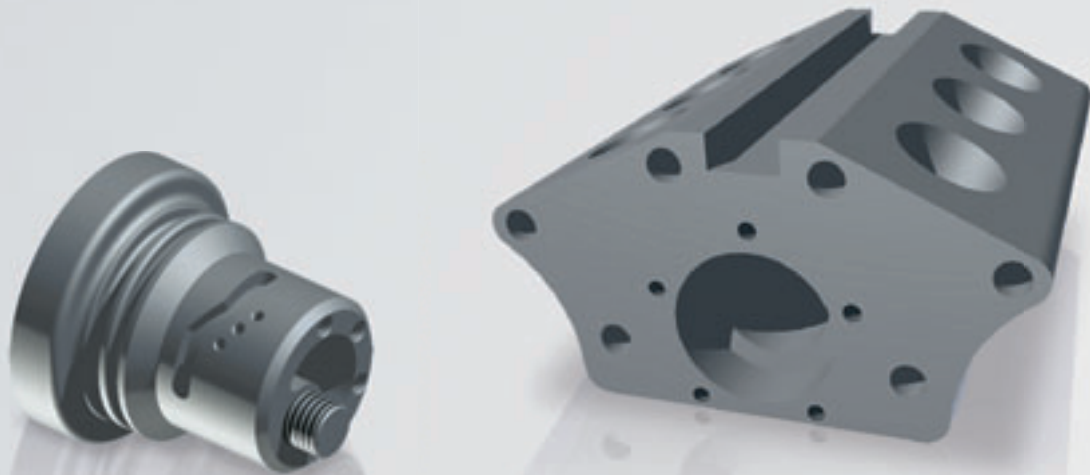

Whether you are machining the front face or peripheral surface of rotating parts, or dealing with milled workpieces in rotated planes, the SINUMERIK 828D is able to transform the machining plane to ensure exactly the right position. This is all done automatically – without the need for CAD/CAM systems or a pocket calculator.

## C-axis utilized to full advantage

Your turning machine's spindle for C-axis mode is more than just a positioning axis. With the SINUMERIK 828D's TRANSMIT function, power tools can be used to carry out any boring and milling processes you require on the end face of the tool.

## The ultimate in peripheral surface machining

The SINUMERIK 828D controls peripheral surface machining perfectly, whether used on turning or milling machines. Slots with parallel walls can even be machined when the tool offset is activated. Geometry axes can be easily programmed using the processing interface. The CNC takes care of everything else.

## Diagonal boreholes handled with ease

The SINUMERIK 828D remains calm under pressure, coping easily with milling machines that are equipped with a swiveling table or inclinable head. Due to its integrated swivel cycle, boring and milling processes can be carried out in any statically rotated workpiece plane – without the need for a CAM system or pocket calculator.

## Counterspindle machining made easy

Having difficulties programming workpiece transfer from the main spindle to the counterspindle? The SINUMERIK 828D's integrated counterspindle cycle makes this process really easy and there is no need for the user to have any special G-code knowledge.

# Tool management: Everything at a glance, everything under control.

The screenshot displays the 'Tool list' window in the SINUMERIK 828D control. The table lists tools with columns for 'Loc.', 'App', 'Tool name', 'D', 'Length', and 'Ø'. The tool 'DRILL\_Ø8\_5' is highlighted. To the right of the table is a 'Tool magazine' panel with buttons for 'Tool measure', 'Edges', 'Unload', 'Delete tool', 'Magazine selection', and 'Sort'. At the bottom is a 'Command center' with icons for 'Tool list', 'Tool wear', 'Magazine', 'Work offset', 'Rear variable', and 'SD Setting data'.

Loc.	App	Tool name	D	Length	Ø
		THREAD_FB_SF1_5	1	100.500	11.000 1.500
1		DRILL_Ø8	1	80.004	5.000 118.0
2		T10 - Capable de couper l'acier sans end	110	50.000	
3		DRILL_Ø8	1	84.411	6.000
4		ERC10032_SF_H_Ø11	1	105.204	16.000
5		ROUGH_Ø8	1	80.704	8.000
6		ROUGH_Ø10	1	95.521	10.000
7		GR_710	1	100.301	8.000 1.200
8		HCO000_CHAMPFH_Ø5	1	80.200	8.500 90.0
9		COA_R_3_T2_SF_Ø12	1	87.100	12.000
10		DRILL_Ø8_Ø	1	104.644	8.000 118.0
11		DRILL_Ø8_5	1	112.705	8.500 118.0
12		GR_7110	1	103.043	10.000 1.500
13		GR_710	1	103.700	8.000 1.000

Tool management made easy. The SINUMERIK 828D features a command center for all tool and magazine tasks so that the machining process is never interrupted. If the tool is at the end of its service life, the SINUMERIK 828D will send a text message (SMS) as necessary – thanks to the Easy Message technology.

## Everything at a glance

The SINUMERIK 828D's tool management system presents tool data and position information on one screen so there is no need to keep switching screens. The tool type is presented in the form of a pictogram. Both primary and secondary cutting edges are indicated for turning tools. Therefore, process stability can be guaranteed simply by looking at the tool table.

## Simply brilliant

The SINUMERIK 828D does not just recognize tools in the tool magazine. Simply create a tool in the tool list and it is ready to be programmed and simulated. At the touch of a button, the tool management function will search for a suitable magazine location. Assign relevant names for the tools, then call the tool name in the CNC part program and the SINUMERIK 828D will automatically take care of everything else for you.

## Powerful

The SINUMERIK 828D can manage up to 256 tools with 512 cutting data records. Naturally, the SINUMERIK 828D monitors tool service life and makes replacement tools available, as needed. Is the tool you want missing from the tool magazine? No problem. The SINUMERIK 828D requests a manual change and machining can continue right away.

# Animated Elements: Perfectly animated operation and programming.

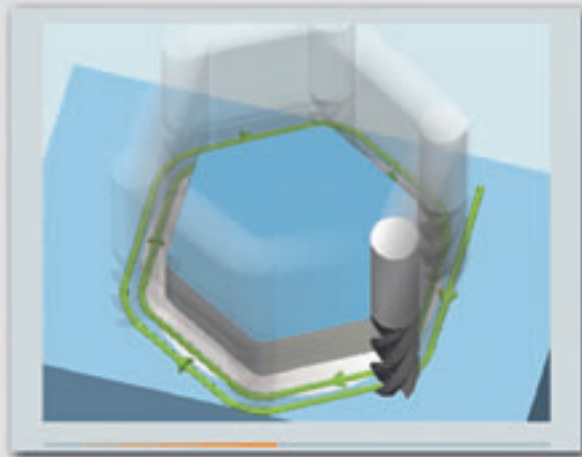
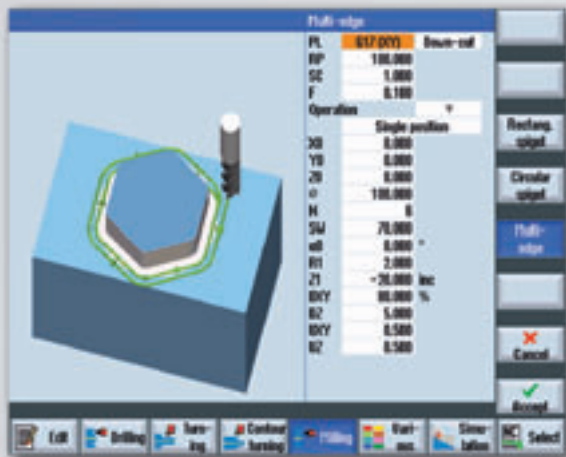

What do the parameters that are input daily into a CNC actually do? The answer is obvious: they are responsible for the machine's movements. Static help screens can only illustrate these movements to a limited extent. That is why the SINUMERIK 828D offers a completely new and highly convenient method of input support: Animated Elements. This input support completely redefines graphic programming and operation thanks to a unique display involving sequences of moving pictures.

## Setup combined with process stability

Need to determine the workpiece zero using a circular spigot? What is the positioning sequence for the tracer and how does the CNC withdraw it? This is where the Animated Elements technology comes in: a short sequence of moving pictures shows you the trace process while ensuring 100% process reliability.

## Accurate programming

What is helical immersion in a milled pocket or how do you tell the difference between chip removal and chip breakage during deep-hole drilling? In such situations, a static help screen would simply show you a collection of arrows that would be very hard to understand. Not so with Animated Elements. This technology illustrates the motional sequence perfectly and with 100% accuracy.

# Input assistance: It's the little things that make everyday life more bearable.

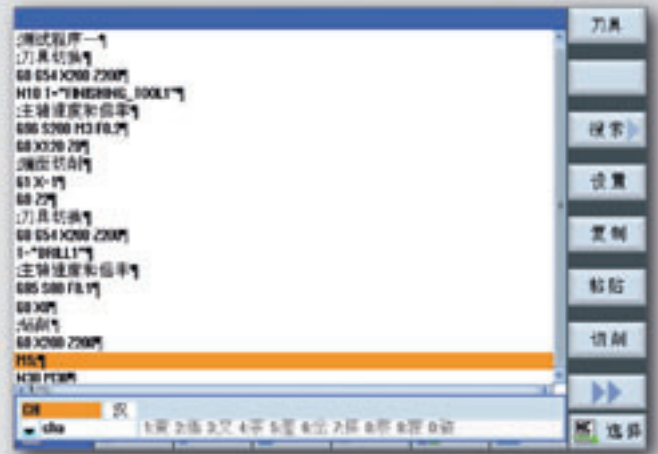
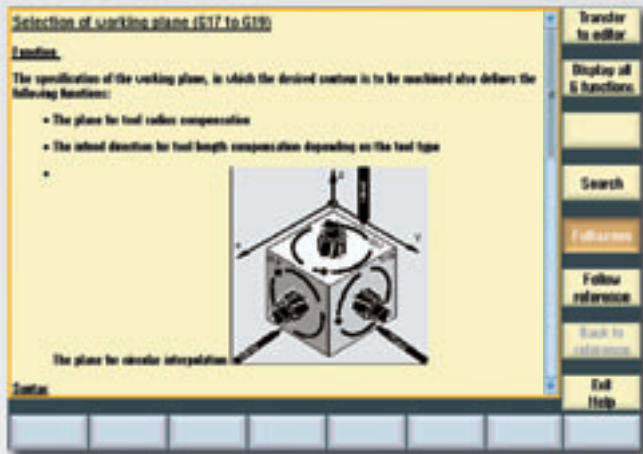

Today's PCs couldn't be more user-friendly. For example, they offer fantastic support in terms of data input. But what about CNCs? Do you sometimes find yourself wondering whether you have been transported back in time? You won't with SINUMERIK 828D. With features such as cursor text, context-sensitive online help and clearly structured menu assistance, you will realize that you are truly in the present.

## Well structured

The SINUMERIK 828D's user interface is divided into clearly structured control areas. Control areas such as the CNC editor or machining parameters can be accessed at the touch of a button thanks to the direct keys on the operator panel.

## Easy-to-use

The SINUMERIK 828D is operated by means of eight horizontal and eight vertical soft keys. This arrangement means that all the operating screens can be accessed with just a few key presses.

## Always helpful

For every text box on the operating screens, the SINUMERIK 828D automatically provides help in the form of cursor text. The SINUMERIK 828D has a complete help system for more detailed information, just like a PC at home.

## A global player

The SINUMERIK 828D allows names of part programs and CNC comments to be input in pictographic languages. Chinese or Korean characters can easily be generated with the integrated keyboard so every user immediately feels at ease.

# programGUIDE: Less machining time – more output.

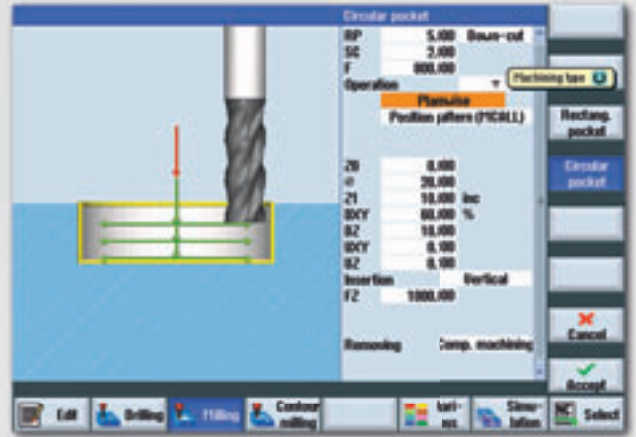
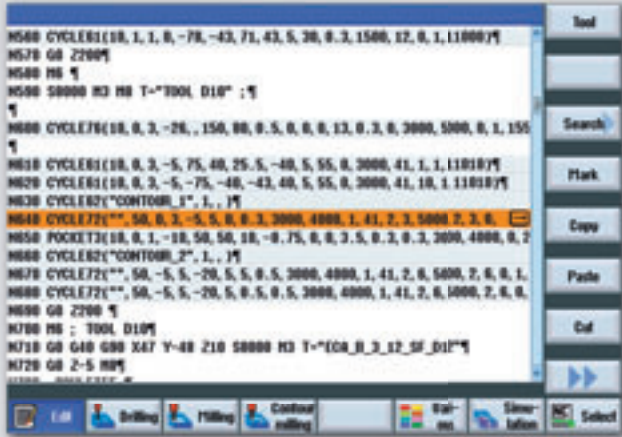

Every second of machining time counts when manufacturing workpieces in large batch sizes. That is why the SINUMERIK 828D boasts a flexible CNC programming language with readable high-level language elements. Thanks to programGUIDE, you can combine this flexibility with the convenience of powerful technology cycles.

## Maximum flexibility

The pairing of DIN/ISO language statements with CNC high-level language elements provides the maximum in flexibility and guarantees minimal machining time. In addition, the SINUMERIK 828D can understand other CNC programs from other manufacturers due to the online ISO dialect interpreter.

## Quick and convenient to program

The text-based CNC editor, with many helpful functions such as “Find and Replace,” enables flexible CNC programs to be generated quickly. programGUIDE allows you to integrate the SINUMERIK 828D’s technology cycles into your CNC programs. With just a few keystrokes, you can tap into the full performance capability of the SINUMERIK 828D – effortlessly and with perfect support from Animated Elements.



# ShopMill and ShopTurn: Simple, step-by-step programming.

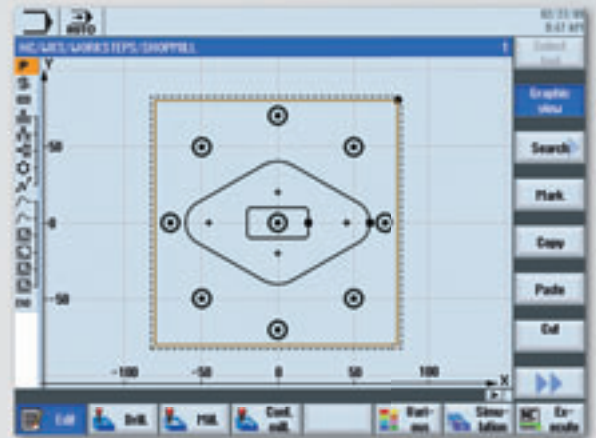
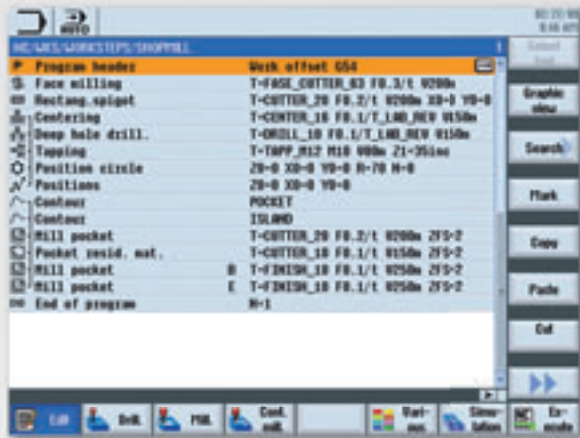

When it comes to manufacturing small batches or individual parts, programming time is the key factor for ensuring productivity. Here, the SINUMERIK 828D is in its element. With ShopMill/ShopTurn sequence programming, the SINUMERIK 828D boasts the most straightforward CNC program editor in the world. Programming takes place without the need for DIN/ISO knowledge in technological steps that are easy to understand.

## Simple and clear

Processes such as drilling, centering, grooving or pocket milling are displayed in the form of steps. This makes the CNC programs – even those used for complex machining processes – extremely compact and easy to read. Associated steps are automatically linked and can be assigned any position pattern. This unique level of programming convenience ensures the shortest possible programming times even in the case of demanding machining tasks.

## Always in the picture

All geometric elements in the CNC program are displayed true-to-scale thanks to the dynamic broken-line graphics. Throughout the entire program, the broken-line graphics adapt automatically to the geometric input. Even if elements are changed or added, they are displayed perfectly on the screen, without simulation. Naturally, CNC simulation is also available in ShopMill/ShopTurn sequence programming. However, this will not be required until the end of the process and, when it is, optimum process stability will also be ensured.

# Technology cycles: Suitable for every type of program.

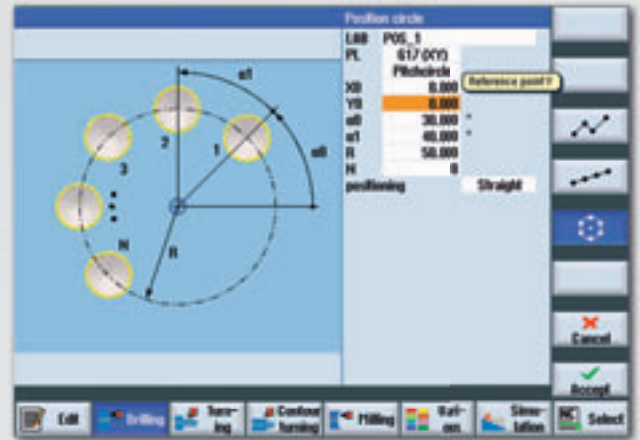
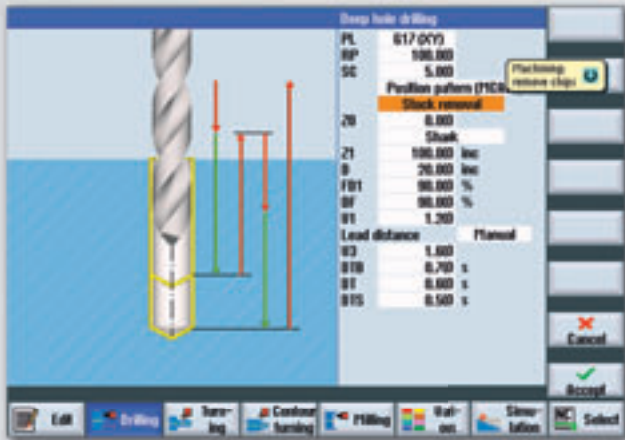

Whether you have programGUIDE or ShopMill/ShopTurn sequencing, you have the full range of technology cycles, position patterns and geometries at your disposal.

## For every standard geometry in every position

Circular pockets, thread undercuts, deep-hole drilling and a whole lot more: the SINUMERIK 828D offers a unique assortment of technology cycles for standard geometries – including engraving cycles. The technology cycles are assigned to machining positions using a large assortment of ready-made position patterns. In addition, this also applies to the front and peripheral surfaces of turned workpieces or rotated planes in the case of milled workpieces.

## Little helpers

Programming of the counterspindle not always easy? It is with the SINUMERIK 828D. An ingeniously straightforward cycle enables the counterspindle to be managed without the need for CNC language commands. Even sloping surfaces can be programmed with ease. The machining plane can be rotated just how the user wants with the integrated swivel cycle, without the need for CAD systems or a pocket calculator.

## For maximum precision

The SINUMERIK 828D ensures continued workpiece accuracy during the machining process with an assortment of measuring cycles.

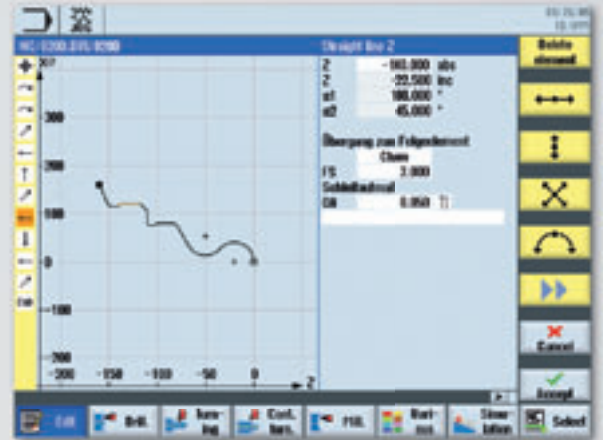
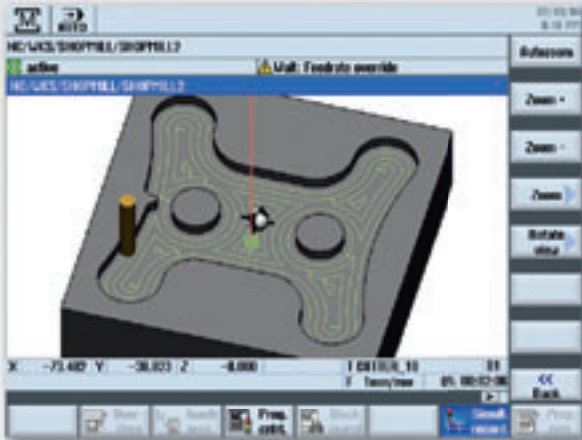

### In good shape

Even complex contours can be generated directly on the CNC thanks to the integrated geometry processor. Partially-defined contour elements are calculated automatically. Grinding stock allowance required for turned workpieces? All you have to do is input the allowance. The SINUMERIK 828D will take care of any additional calculations. In addition, DXF files can also be processed offline. Simply use a CAD reader to convert your DXF files into the SINUMERIK geometric format.

### Pockets with islands required?

The integrated geometry processor makes it easy to generate pocket and island contours. The SINUMERIK 828D generates tool paths automatically. To achieve maximum productivity, parts can be rough machined with a large milling tool. Optional identification of residual material enables targeted remachining of the residual corners using a smaller milling tool. This feature can also be used on turning machines equipped with live tools.

### Worried about complex contours of rotation?

The machining of complex inside contours is a particular challenge for any CNC. Even complex geometries with relief cuts can be machined. You can choose whether you want to turn the contour in the conventional way or plunge-cut it. Contour machining can also be configured exactly as you wish. This means you can choose the right tool and the best cutting values for each subsegment. The geometric tracking function takes care of the optional identification of residual material automatically.

# CNC simulation: Maximum process stability guaranteed.

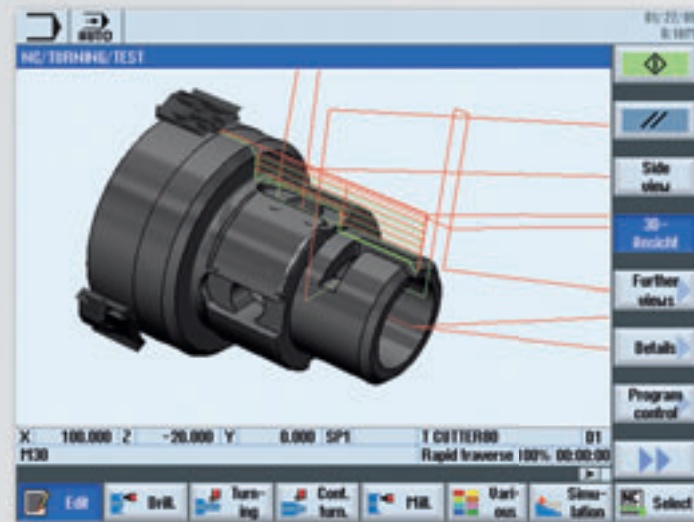

Ensuring machine productivity is partly a question of preparing well for the machining process. The SINUMERIK 828D's powerful CNC simulation feature helps in this regard. And not just by a brilliant simulation display. The calculation of the machining time provides the ideal basis for determining workpiece costs.

## Maximum process stability

The SINUMERIK 828D's simulation feature guarantees maximum process stability because it uses the actual geometrical data of the tools installed on the machine. Therefore, the SINUMERIK 828D doesn't just look good, it shows an exact image of the desired machining process.

## In all circumstances

Any CNC that is available on the market today is capable of generating simulations in top and side view. But what about simulations involving kinematic transformations? Even here, the SINUMERIK 828D shows what it is made of. Whether it is being used for front and peripheral surfaces in the case of turning machines or rotated machining planes in the case of milling machines, the SINUMERIK 828D can simulate machining whatever the circumstances.

## Optimum view guaranteed

Worried about detailed machining? Not a problem for the SINUMERIK 828D. The user can zoom in to the smallest corners of the CNC simulation without having to restart it. In addition, the simulation can be interrupted at any time and controlled in terms of speed. As a result, even the smallest detail is not overlooked.

# Machine setup made easy.



Particularly within the context of job shop manufacturing (small batch production), machines frequently need to be reset.

Tracer processes for workpiece setup or process measurement for the establishment of tool geometries are provided in a format tailored to the user's requirements.

## Everything as it should be

Blanks often need to be shaped prior to machining. The SINUMERIK 828D does not require any additional CNC part program for this purpose. A workpiece can be face milled or face turned simply by setting the relevant parameters in setup mode. Simply select NC Start and off you go. Want to bore clamping jaws? The SINUMERIK 828D can also do this at the touch of a button.

## Perfectly aligned

All you need to do is trace the edge, corner or boreholes and the system will determine the clamping position including the workpiece's basic rotation. The SINUMERIK 828D offers a variety of measurement variants – even for sloping workpiece surfaces.

## Perfectly equipped

The SINUMERIK 828D makes it really easy to quickly determine the tool length. Whether you are determining the tool geometry by "scratching" or using a tool measurement system, all you need to do is press a button and the geometry will be stored in the CNC's tool offset memory.

# User memory and data transfer: All data under control.



**Text message (SMS), USB and Ethernet – the SINUMERIK 828D uses the latest methods of communication to guarantee data transfer at all times.**

## Unlimited user memory

The SINUMERIK 828D is already equipped with a basic 3 or 5 MB user memory. If this memory capacity is not sufficient, then memory can be expanded by inserting a Compact Flash (CF) Card into the front port.

## Perfect diagnostics

Need quick and easy service? The SINUMERIK 828D is available to you from anywhere. The remote diagnostics function enables remote operation as well as supporting file transfer. The contents of the CNC screen are displayed directly on the workstation where the remote diagnostics are being carried out. Simply connect a modem that supports the required data transfer method (analog, ISDN, etc.)

to the front Ethernet port of the SINUMERIK 828D and you're online. The CNC also offers a user-friendly PC tool in the form of the RCS Commander.

## Already networked?

The SINUMERIK 828D can be integrated into any company network via a 100Base-T Ethernet port. And all without the need for additional software protocols. Simply connect, configure and get on the information superhighway.

## Got your notebook handy?

The days of laborious serial data transfer are over. The RCS Commander is a powerful and free PC tool which can be used to easily transfer data to the CNC and using the Drag and Drop method. A treat for service technicians: the CNC's screen contents can be easily viewed on a PC using the RCS Commander. Simply connect the RCS Commander to the front Ethernet port. The network configuration will automatically pick up the SINUMERIK 828D. No expertise in networking is required.

# Easy Message: Always informed, wherever you are.

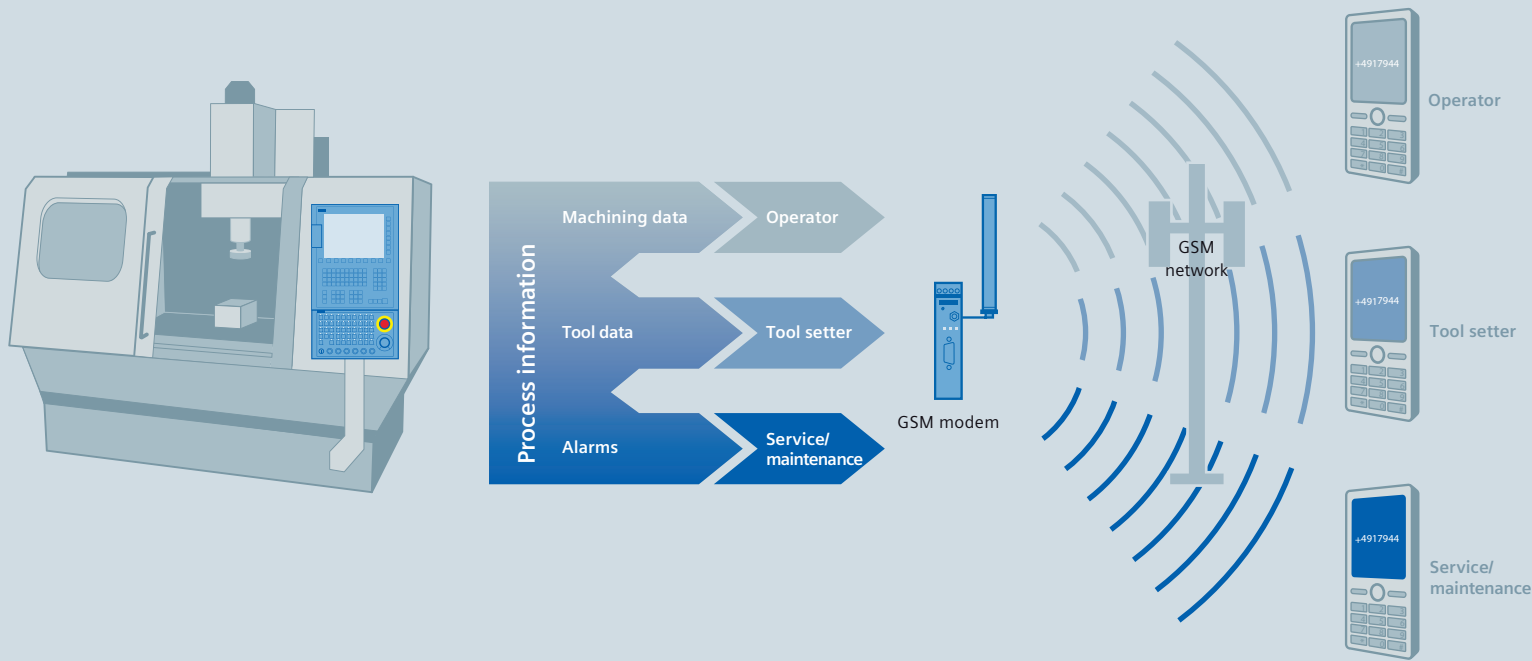

Easy Message is an innovative modern communications function. It represents a new way of increasing machine productivity – regardless of where you are. Get a hold of the process information relating to your machine very easily – by text message (SMS) on your mobile phone.

## Just install a SIM card and you're ready to go!

All you need to use Easy Message is the optional mobile communications modem and a SIM card of your choice. This means you are free to choose the mobile phone contract that suits you best. The mobile communications modem relies on the globally-established GSM mobile communications standard – naturally with quad-band technology. The associated mobile communications antenna guarantees optimum quality of transmission even in harsh industrial environments.

## The right information for each person

Easy Message offers a user administration feature to ensure that each person involved is supplied with exactly the information they need. This means that machine operators can obtain information about the status of the current machining operation, whereas information about tool wear can be transmitted directly to members of the tool planning team. In addition, you can send any text (SMS) message you want to directly from the CNC part program. This means that the sky is the limit when it comes to flexibility.

## Perfect service

There is an increasing focus on all aspects of machine tool customer service and support. Easy Message also provides an excellent platform in this respect. As well as error messages, maintenance information from the service planner can be sent via text message (SMS), too. Impress your customers with extremely short customer support waiting times with the help of Easy Message.

# Easy Extend: Expand your machine at the touch of a button.

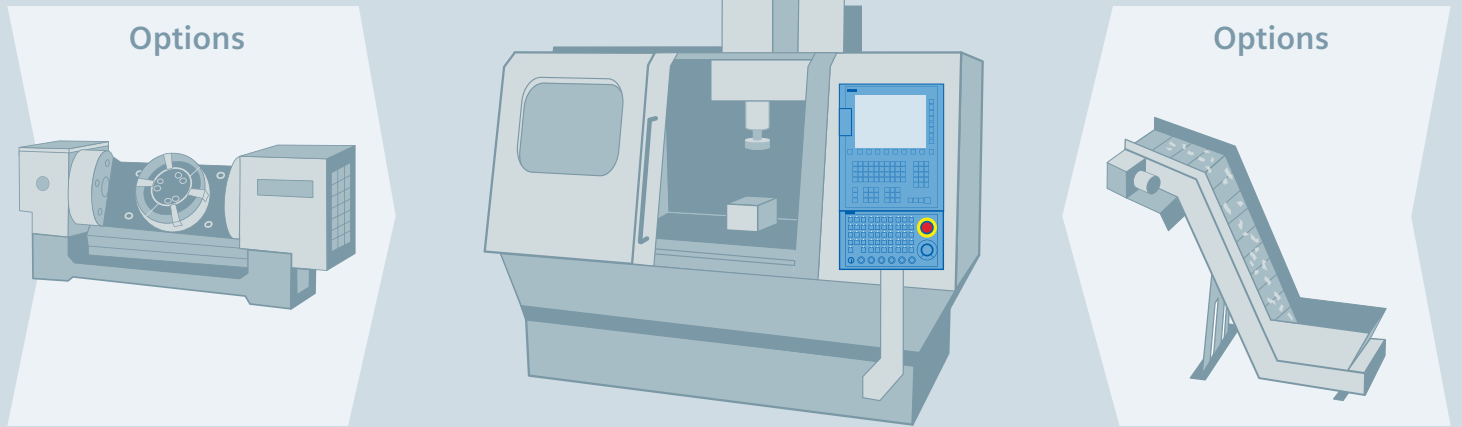

How difficult is it to subsequently install an optional component on your machine? With a SINUMERIK 828D, it's really easy.

Easy Extend provides a simple way of carrying out the necessary groundwork at the factory prior to commissioning optional machine units. Once installed on-site, everything runs automatically...and at the touch of a button.

## Easy-to-add machine components

The SINUMERIK 828D allows you to carry out the necessary groundwork for any optional machine components, which might later be added at the request of your customers, as early as the commissioning stage. With Easy Extend, any necessary system parameters, such as those required for attaching a dividing unit (A-axis), can be stored in a script file. All the on-site service technician needs to do is install a SINAMICS power unit, if necessary. Then the machine components to be installed can be selected. Easy Extend automatically installs the necessary system parameters. The component is ready for use at the touch of a button.

## All maintenance tasks under control

The SINUMERIK 828D helps you monitor any essential maintenance intervals associated with your machine on the basis of the service planner. The best thing about this is that you don't need to configure any user displays of your own. Simply enter the desired maintenance interval into the service planner (the time left until the coolant reservoir needs to be changed, for example). The SINUMERIK 828D automatically informs the operator about the pending maintenance work. In addition, there is no need for you to define any maintenance intervals for the SINUMERIK 828D itself. The fact that there is no wear on parts (such as a hard disk or fan) means that maintenance tasks are not required.



# Easy Archive: Commissioning and service – well prepared and quickly executed.

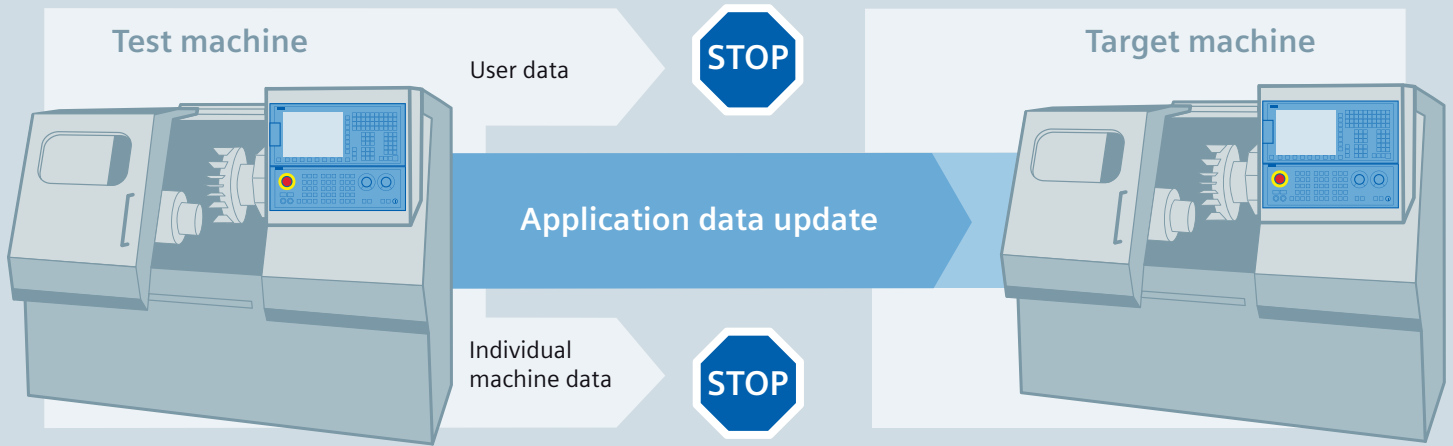

We aim for straightforward commissioning and straightforward service. Simply unpack and turn on your SINUMERIK 828D. You will find that the parameters have already been set to allow straightforward and reliable commissioning. And if you ever need to upgrade your application in the field, this can be done with Easy Archive, which requires no expert knowledge. Easy Archive is an ingenious process, which enables you to upgrade seamlessly without losing your momentum.

## Perfectly prepared

The SINUMERIK 828D's interface data is pre-defined on delivery and ready for a typical machine application. This means commissioning can be carried out rather quickly.

## Software upgrading made easy

The SINUMERIK 828D features a brand-new data management process. Easy Archive allows you to upgrade the machine's interface data in the field without having to back up your customers' user data and the individual machine settings (such as reference positions or compensation data) in advance. Use your test machine to create an upgrade archive.

Easy Archive guarantees problem-free machine operation in conjunction with all user data, such as CNC part programs or tool data, as well as the geometric machine data that was originally input. And the great thing about Easy Archive is that you don't need any software tools. Easy Archive can be controlled via the SINUMERIK 828D user interface.

## Suitable for your own data

You can also use Easy Archive for your own application data, for example in the PLC. Simply categorize your application data by assigning one of the Easy Archive data classes and you will soon be enjoying the benefits of the SINUMERIK 828D's innovative approach to archiving.

# Drives and motors: For powerful machine tool applications.



Everyone has a tendency to focus exclusively on the CNC. But what is it that actually gets the machine going? Correct: the components hard at work behind the scenes – the drives and motors. Thanks to SINAMICS, the SINUMERIK 828D runs in top form. SINUMERIK and SINAMICS, the perfectly coordinated motion control system consisting of CNC, drive and motors guarantees perfect workpiece surfaces and extremely short machining times, thereby delivering maximum productivity.

## Superb dynamic performance and perfect surfaces

SINAMICS S120 provides a unique closed-loop position control process for the toughest dynamic response requirements in the form of Dynamic Servo Control (DSC). An adaptive current controller helps to ensure maximum motor performance. As a result, impressive acceleration values can be achieved, thereby increasing machine productivity significantly. The intelligent filter functions mean that the natural resonances of the machine can be almost completely suppressed. This, combined with high-precision, three-phase detection of the actual value and actual position value acquisition in the sub-nanometer range, ensures that perfectly smooth workpiece surfaces can be achieved.

## Flexible and energy-efficient

SINAMICS S120 can be used in all line system configurations (TN, IT, IT) with a voltage range of between 380 V and 480 V without the need for an additional series transformer. Incidentally, 70% of all machine tools happen to be operated within this voltage range. Thanks to energy recovery, it is not just your control cabinet that will be able to keep its cool at full infeed power. In these times of constantly increasing energy prices, the money you will save on power costs will give you additional peace-of-mind.

## DRIVE-CLiQ: simply plug and play

If you are searching for the perfect “information superhighway” in a device, you need to look no further than SINAMICS, which is equipped with DRIVE-CLiQ. The electronic name plates of all connected components, including motors and encoders, are detected automatically. This is achieved with a single data protocol. All components are networked using just one cable type – simply and clearly. Therefore, commissioning of the drive system is child’s play. Want to add new components later on? No sweat: SINAMICS automatically recognizes the new drive components – simply plug and play.



### Superb dynamic performance

Whatever your requirements – whether high static torques, high maximum speeds, perfectly smooth running characteristics, additional holding brakes or whatever else you might need – the 1FK7 and 1FT7 SINAMICS servomotor series are perfectly suited to any task. With their high degree of protection, strong bearings and vibration-free design, the synchronous servomotors provide a reliable drive source for your machine. High-quality magnet materials give the system a very high power density. As a result, extremely small motor dimensions can be supported and even very tight installation conditions can be overcome.

### Sheer power

Maximum spindle speed and machine cutting performance, as well as minimal ramp-up time, ensure optimum productivity. SINAMICS main spindle motors provide the ideal platform for any demanding spindle solution. The main spindle motors on offer range from standard motors with asynchronous and synchronous technology to built-in motors that are directly integrated into the machine's mechanical system. Of course, there is also a wide power spectrum available.

### Optimal actual value acquisition

SINAMICS motors are equipped with state-of-the-art encoder technology. High-precision optical encoders with a resolution of up to 24 bits ensure maximum contour precision and positioning accuracy. In addition, the absolute value sensors do not require expensive back-up batteries. This is not just good news for your wallet, but also for the environment. If necessary, the encoders can be replaced quickly and easily thanks to the intelligent coupling technology, and without any need for adjustment. This makes them very easy to service.

# PLC: A systematic approach to automation.

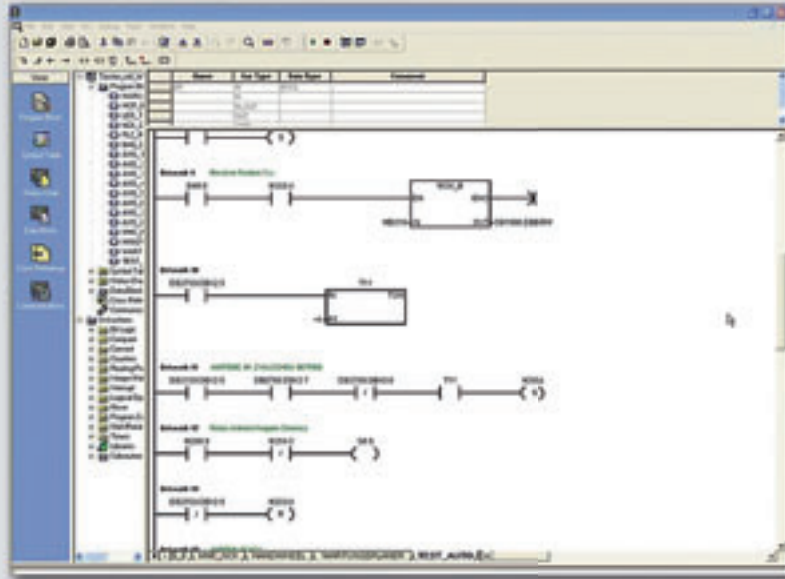

The PLC interface control has a decisive role to play in terms of increasing productivity. Machining downtimes (when changing tools, for example) need to be kept to a minimum. That is why the SINUMERIK 828D is equipped with an interface control that is designed help your machine achieve maximum output.

## Quick to program

The PLC can be programmed easily and logically using universally established ladder diagram technology (Ladder Steps) – either with a PLC programming tool on a PC or a PLC editor integrated into SINUMERIK 828D's user interface in case of minor extensions.

## Optimal I/O modules

Especially designed input/output modules are available for the SINUMERIK 828D. These modules have 72 digital inputs and 48 digital outputs as well as two analog inputs and outputs, which are of course isolated to ensure the best possible process stability.

## Plug and Play

The SINUMERIK 828D automatically recognizes the PLC I/O modules. This makes commissioning and subsequent expansion really easy, without the need for expensive configuration work or additional configuring tools.

## Incredibly fast

The SINUMERIK 828D's PLC is capable of processing 24,000 logic instructions in their entirety within a time scale that is guaranteed to remain constant. In the case of time-critical process signals, an additional servo synchronous high-speed PLC task accelerates the response time. This is a real advantage in terms of productivity.

## Straightforward diagnostics

If a mechanism of the machine ever "jams," the SINUMERIK 828D is even perfectly equipped to deal with this. A PLC viewer integrated into the SINUMERIK 828D's user interface enables the user to determine the source of the error as quickly as possible.

## Easy interfacing

With an optional PN/PN Interface the SINUMERIK 828D can communicate with additional automation modules such as a roboter or connect to a supervisory PLC network. Plug & Play without tedious configuration efforts.

# System overview

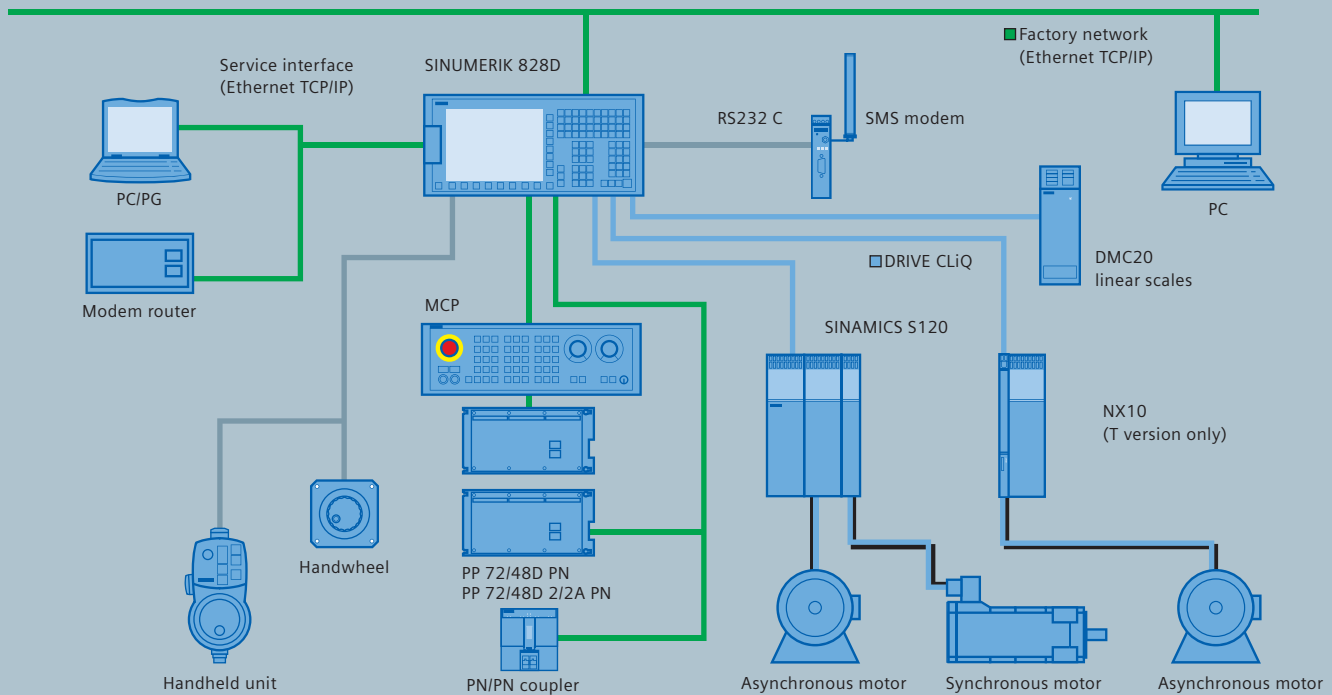

**SINUMERIK, SINAMICS and their accessory components are a well-rehearsed team.**

**This perfectly coordinated motion control system guarantees optimum workpiece quality combined with minimal machining time.**

## Top-notch communication

The intelligent PLC and drive interfaces guarantee top-notch communication. The SINUMERIK 828D detects the operating state of all connected components. This makes it really easy to perform diagnostics on the entire system.

## Siemens accessories

Add Siemens components to your system. These components are perfectly matched to one another and guarantee maximum machine availability. We offer an extensive range of components such as machine control panels and user handwheels. With our Motion Connect products, we also offer a large assortment of high-quality cables and connections that are measured to the exact centimeter, if required.



# Technical data (Excerpt)

	PPU 260/261		PPU 280/281	
	Turning	Milling	Turning	Milling
<b>System performance</b>				
Basic quantity of axes/spindles/auxiliary axes	3	4	3	4
Each additional axis/spindle	○	○	○	○
Each additional axis/spindle	○	○	○	○
Maximum configuration axes/spindles/auxiliary axes	6	6	8	6
Maximum number of interpolating axes	4	4	4	4
Maximum number of machining channels	1	1	1	1
Minimum block cycle time	~6ms	~2ms	~6ms	~1ms
CNC user memory (extendable by user-CF-card)	3 MByte	3 MByte	5 MByte	5 MByte
<b>CNC Functions</b>				
Tool management with monitoring of tool life and workpiece count	●	●	●	●
Replacement tools	○	○	○	○
Maximum number of tools/cutting edges	128/256	128/256	256/512	256/512
Number of settable zero-offsets	100	100	100	100
Safety Integrated	★	★	★	★
Asynchronous subroutines ASUB	●	●	●	●
Synchronized actions and high-speed auxiliary function output	●	●	●	●
Acceleration with jerk limitation	●	●	●	●
Look Ahead (number of blocks)	1	100	1	150
Compressor for 3-axis machining	–	●	–	●
Advanced Surface	–	●	–	●
A, B, C spline interpolation	○	○	○	○
TRANSMIT and peripheral surface transformation	○	○	○	○
Travel to fixed stop	●	●	●	●
Travel to fixed stop with Force Control	○	○	○	○
Inclined axis for nonorthogonal Y-axis	–	–	○	–
Synchronous spindle function for subspindle (CP Static)	–	–	○	–
Synchronous spindle function multiedge turning (CP Basic)	○	–	○	–
Pair of synchronized axes Gantry	○	○	○	○
Temperature compensation	●	●	●	●
Bidirectional leadscrew error compensation	○	○	○	○
Multi-dimensional sag compensation	○	○	○	○
Master/slave for drives	○	–	○	–
Analysis of internal drive values	○	–	○	–

★ in preparation ● standard (basic scope) ○ CNC option – not available

	PPU 260/261		PPU 280/281	
	Turning	Milling	Turning	Milling
<b>CNC Programming and Operation</b>				
Programming language (DIN 66025 and high-level language expansion)	●	●	●	●
Online ISO dialect interpreter	●	●	●	●
Technology cycles for drilling and milling	●	●	●	●
Technology cycles for turning	●	–	●	–
Residual material detection and machining	○	○	○	○
Programming support for technology cycles ( <b>programGUIDE</b> )	●	●	●	●
ShopTurn/ShopMill machining step programming	○	○	○	○
Measuring cycles for drilling/milling and turning	○	○	○	○
Simulation in plane display	●	●	●	●
Simulation in 3-D display	○	○	○	○
Simultaneous recording (real-time simulation of current machining operation)	○	○	○	○
Extended operator functions for complex turning and milling tasks	○	○	○	○
Contour handwheel	○	○	○	○
Network drive management	○	○	○	○
Remote diagnostics function RCS Host	○	○	○	○
<b>PLC Functions</b>				
Integrated PLC based on SIMATIC S7-200	●	●	●	●
PLC periphery modules PP 72/48D PN, PP 72/48D 2/2A PN	○	○	○	○
Ladder viewer and add-on editor on board	●	●	●	●
Processing time per PLC command	0.025µs	0.025µs	0.02µs	0.02µs
Maximum number of PLC ladder steps	24,000	24,000	24,000	24,000
Servo-synchronous High Speed PLC Task	●	●	●	●
Reaction time to process events (terminal to terminal)	~7.5ms	~7.5ms	~4.5ms	~4.5ms
Maximum number of digital inputs/outputs	288/192	288/192	360/240	360/240
Maximum number of analogue inputs/outputs	8/8	8/8	10/10	10/10
PN/PN coupler	○	○	○	○
<b>Commissioning and Service Functions</b>				
<b>Easy Screen</b> easy creation of user screens (OA Runtime License from 5 user screens)	○	○	○	○
<b>Service Planner</b> planner for maintenance tasks	●	●	●	●
<b>Easy Extend</b> management of machine components	●	●	●	●
<b>Easy Archive</b> data archiving	●	●	●	●

## Get more information

Everything you need to know about SINUMERIK CNC equipment:  
[www.siemens.com/sinumerik](http://www.siemens.com/sinumerik)

Everything you need to know about shopfloor production:  
[www.siemens.com/cnc4you](http://www.siemens.com/cnc4you)

Everything you need to know about our service portfolio  
SINUMERIK Manufacturing Excellence at:  
[www.siemens.com/sinumerik/manufacturing-excellence](http://www.siemens.com/sinumerik/manufacturing-excellence)

Information on training sessions:  
[www.siemens.com/sinumerik/training](http://www.siemens.com/sinumerik/training)

Siemens AG  
Industry Sector  
Drive Technologies  
P.O. Box 31 80  
91050 ERLANGEN  
GERMANY

[www.siemens.com/sinumerik](http://www.siemens.com/sinumerik)

Subject to change without prior notice  
Order No.: E20001-A840-P610-X-7600  
Dispo 06311  
WÜ/17743 GD.MC.10.TIGE.52.9.01 WS 02091.  
Printed in Germany  
© Siemens AG 2009

The information provided in this brochure contains merely general descriptions or characteristics of performance which in actual case of use do not always apply as described or which may change as a result of further development of the products. An obligation to provide the respective characteristics shall only exist if expressly agreed in the terms of contract.

All product designations may be trademarks or product names of Siemens AG or supplier companies whose use by third parties for their own purposes could violate the rights of the owners.